

60cm Fan Forced Oven

BUILT-IN OVEN

PRODUCT CODE: **EV600BSS3**



eurocooking



FEATURES:

- + 5 multi-functions
- + Contained cavity cooling with tangential cooling fan
- + Triple glazed easy removable door
- + 120 minute timer with auto shut off
- + Removable internal side-shelves
- + Stainless steel / black contemporary design



Warranty

5 MULTI-FUNCTIONS:



OVEN LIGHT

The oven light will automatically turn on once any function is selected, helps to monitor the progress of your cooking.



FAN FORCED COOKING

For the ultimate roast or perfect batch of pastries. The element surrounding the fan delivers even heat for even cooking results, approx. 160°C - 180°C is recommended



FAN GRILL

This function is perfect for fish, chicken Fillets or meat Cutlets. The door can be left closed whilst grilling and Browning will occur from the top element. The fan Circulates the heat for all over cooking.



FULL GRILL

The perfect option for quick grilling. Toast your favourite meals or finish off the tops of your recipes.



DEFROST

In defrost mode, no heating elements are used. Only the fan is activated to circulate air inside the oven for defrosting and not cooking the food.

TRIPLE GLAZED EASILY REMOVABLE DOOR

This oven is equipped with a triple glazed glass door; ensuring minimal heat will escape during the cooking process. Also to ensure a hassle free clean, the oven door can be easily removed by simply unclipping the inner glass.

CAVITY COOLING SYSTEM

To ensure that control knobs are constantly cool and surrounding cupboards are protected, the EV600BSS3 oven has a contained cavity cooling system with internal cooling fan.

SPECIFICATIONS:

Electrical Requirements

This oven can be connected to a 15 AMP wiring connection. For more information please refer to a qualified electrician.

Power Consumption

220-240v - 50-60Hz - 2.7-3.22Kw

Oven Volume Capacity

67 litres (gross) - 64 litres (net)

Weight

37.5kg (gross) - 34kg (net)

PRODUCT DIMENSIONS

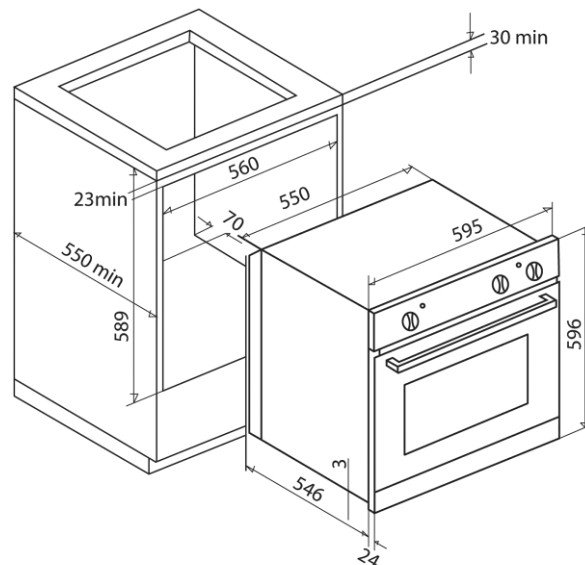

CLEANING AND MAINTENANCE

Easy clean AAA grade enamel interior.

Clean stainless steel using only recommended stainless steel cleaning products. No abrasives, corrosive detergents, bleaches or acids not required for cleaning the oven.