

Haier

- HWO60S8EPB2
- HWO60S8EPX2

USER INSTRUCTIONS

OVENS _____

EN **02**

SAFETY AND WARNINGS

Your oven has been carefully designed to operate safely during normal cooking procedures. Please keep the following safety instructions in mind when you are using it:

⚠ WARNING!



Electrical Shock Hazard

Turn the oven off at the wall before replacing the oven lamp or before carrying out any work or maintenance on it. Failure to follow this advice may result in electrical shock or death.

⚠ WARNING!

Fire Hazard

Do not place aluminium foil, dishes, trays, water or ice on the oven floor during cooking, as doing so will irreversibly damage the enamel; lining the oven with aluminium foil or single use protection available from stores may even cause fire.



Never use your appliance for warming or heating the room.

Persons could be burned or injured or a fire could start.

Storage in or on appliance: flammable materials should not be stored in an oven or near its surface.

Failure to follow this advice may result in overheating, burning, and injury.

⚠ WARNING!

Hot Surface Hazard

Accessible parts may become hot when in use. To avoid burns and scalds, be careful not to touch any hot part and keep children away. Use oven mitts or other protection when handling hot surfaces such as oven shelves or dishes.

Use care when opening the oven door. Let hot air or steam escape before removing or replacing food.

Do not touch heating elements or interior surfaces of the oven. Heating elements may be hot even though they are dark in colour.



Interior surfaces of an oven become hot enough to cause burns.

During and after use, do not touch, or let clothing or other flammable materials contact heating elements or interior surfaces of the oven until they have had sufficient time to cool.

Other surfaces of the appliance may become hot enough to cause burns - among these surfaces are the oven vent, the surface near the oven vent, and the oven door.

Failure to follow this advice could result in burns and scalds.

⚠ WARNING!

Cut Hazard



Take care during installation of the oven - some edges are sharp.

Failure to use caution could result in injury or cuts.

IMPORTANT SAFETY INSTRUCTIONS

To reduce the risk of fire, electrical shock, injury to persons or damage when using the oven, follow the important safety instructions listed below:

- Read all the instructions before using the oven. Use the oven only for its intended purpose as described in these instructions.
- Proper installation: be sure your appliance is properly installed and earthed by a qualified technician.
- Isolating switch: make sure this oven is connected to a circuit which incorporates an isolating switch providing omnipolar disconnection from the power supply the device must have contact separation compliant to the requirements for overvoltage category III, must bear the maximum connected load and in must be in line with current legislation. The switch must be incorporated in the fixed wiring in accordance to the wiring rules.

The yellow-green earth cable should not be interrupted by the device and must be easily accessible when the appliance is installed.

IF THE OVEN IS PROVIDED BY THE MANUFACTURER WITHOUT PLUG THE APPLIANCE MUST NOT BE CONNECTED TO THE POWER SOURCE USING PLUG OR SOCKETS, BUT MUST BE DIRECTLY CONNECTED TO THE SUPPLY MAINS.

SAFETY AND WARNINGS

- Household appliances are not intended to be played with by children.

- Do not leave children alone.

Children should not be left alone or unattended in the area where the appliance is in use. They should never be allowed to sit or stand on any part of the appliance.

- Children of less than 8 years old must be kept away from the appliance unless continuously supervised.

This appliance can be used by children aged from 8 years and above, and persons with reduced physical, sensory or mental capabilities or lack of experience and knowledge, if they have been given supervision or instruction concerning the use of the appliance in a safe way and they understand the hazards involved.

Cleaning and user maintenance shall not be done by children without supervision.

- Do not place heavy objects on the oven door.

- Wear proper apparel. Do not wear loose fitting or hanging garments when using the appliance. They could ignite or melt if they touch an element or hot surface and you could be burned.

- User servicing: do not repair or replace any part of the appliance unless specifically recommended in the manual. All other servicing should be referred to a qualified technician.

- Do not use water on grease fires. Smother the fire

SAFETY AND WARNINGS

or flame or use a dry chemical or foam type extinguisher.

- Use only dry oven mitts or potholders.

Moist or damp potholders on hot surfaces could result in burns from steam. Do not let potholders touch hot areas or heating elements. Do not use a towel or a bulky cloth for a potholder. It could catch fire.

- Do not heat unopened food containers. They can build up pressure that may cause the container to burst and result in injury.

- Safe food handling: leave food in the oven for as short a time as possible before and after cooking. This is to avoid contamination by organisms which may cause food poisoning. Take particular care during warm weather.

- Always keep oven vents unobstructed.

- Do not operate your appliance by means of an external timer or separate remote-control system.

- Caution: Hot air can blow from the vent at the top of the oven as part of the oven's cooling system.

- Placement of oven shelves: always position shelves in the desired location while the oven is cool (before preheating). If a shelf must be removed while the oven is hot, do not let the oven mitts or potholder contact hot heating elements in the oven or the base of the oven.

SAFETY AND WARNINGS

- When you place the shelf inside, make sure that the stop is directed upwards and in the back of the cavity. The shelf must be inserted completely into the cavity.
- Do not clean the oven seal or use any oven-cleaning products on it. It is essential for a good seal, which ensures that the oven operates efficiently. Care should be taken not to rub, damage or move it.
- Do not use oven cleaners, harsh/abrasive cleaning agents, waxes, or polishes. No commercial oven cleaner, oven liner, or protective coating of any kind should be used in or around any part of the oven. Do not use harsh/abrasive cleaners, scourers or sharp metal scrapers to clean the oven door glass since they scratch the surface, which may result in the glass shattering.
- Clean only the parts listed in this manual.
- Do not use a steam cleaner to clean any part of the oven.
- Do not store things children might want above the oven. Children could be burned or injured while climbing on the oven to retrieve items.
- Do not install or operate the appliance if it is damaged or not working properly. If you receive a damaged product, contact your dealer or installer immediately.
- Use only bakeware approved for oven use. Follow the bakeware manufacturer's instructions.

SAFETY AND WARNINGS

- No additional operation/setting is required in order to operate the appliance at the rated frequencies.
- If the power cable is damaged, it should be substituted with a cable or special bundle available from the manufacturer or by contacting the customer service department. The type of power cable must be H05V2V2-F. This operation should be carried out by a suitably qualified professional. The earth conductor (yellow-green) must be approximately 10 mm longer than the other conductors. For any repairs, refer only to the Customer Care Department and request the use of original spare parts. Failure to comply with the above can compromise the safety of the appliance and invalidate the guarantee.
- The oven must be switched off before removing the removable parts. After cleaning, reassemble them according the instructions.
- **WARNING:** Never remove the oven door seal.
- When inserting the grid tray pay attention that the anti-slide edge is positioned rearwards and upwards
- The appliance must not be installed behind a decorative door in order to avoid overheating.
- Excess spillage must be removed before cleaning using a self-clean cycle.
- Before starting a self-clean cycle, remove oven shelves and all other cookware and/or utensils and accessories, and wipe up large food spills or grease

SAFETY AND WARNINGS

deposits, using a damp sponge. Do not use detergent.

- Do not place towels on the oven during the cleaning cycle

- Before starting a self-clean cycle, ensure you move any pet birds to another, closed and well-ventilated room.

Some pet birds are extremely sensitive to the fumes given off during a self-clean cycle and may die if left in the same room as the oven during such a cycle.

- During a self-clean cycle, the oven reaches higher temperatures than it does for cooking. Under such conditions, the surfaces may get hotter than usual. Children therefore should be kept at a safe distance

- In ovens with the meat probe it is necessary, prior the self-clean cycle, to close the hole with the nut provided.

The hole should always be closed if the meat probe is not used.

- Only use the temperature probe recommended for this oven.

- If a hob has been fitted above the oven, the hob shouldn't be used during a self-clean cycle, to prevent the hob from overheating.

- Before using the appliance, it must be installed following installation instruction at the end of this manual.

General Instructions	1.1 Safety indications 1.2 Electrical safety 1.3 Recommendations 1.4 Waste management
13	

Product Description	2.1 Overview 2.2 Accessories 2.3 First use
15	

Use of the Oven	3.1 Display description 3.2 Cooking modes
16	

Oven Cleaning and Maintenance	4.1 General notes on cleaning 4.2 Pyrolysis 4.3 Maintenance
19	<ul style="list-style-type: none">• Instruction for removal and cleaning of the side racks• Removal and cleaning of the door glass• Changing the bulb

Troubleshooting	5.1 F.A.Q.
22	

1. General Instructions

We thank you for choosing one of our products. For the best results with your oven, you should read this manual carefully and retain it for future reference. Before installing the oven, take note of the serial number so that you can give it to customer service staff if any repairs are required. Having removed the oven from its packaging, check that it has not been damaged during transportation. If you have doubts, do not use the oven and refer to a qualified technician for advice. Keep all of the packaging material (plastic bags, polystyrene, nails) out of the reach of children. When the oven is switched on for the first time, strong smelling smoke can develop, which is caused by the glue on the insulation panels surrounding the oven heating for the first time. This is absolutely normal and, if it occurs, you should wait for the smoke to dissipate before putting food in the oven. The manufacturer accepts no responsibility in cases where the instructions contained in this document are not observed.



NOTE: the oven functions, properties and accessories cited in this manual will vary, depending on the model you have purchased.

1.1 Safety Indications

Only use the oven for its intended purpose, that is only for the cooking of foods; any other use, for example as a heat source, is considered improper and therefore dangerous. The manufacturer cannot be held responsible for any damage resulting from improper, incorrect or unreasonable usage.

The use of any electrical appliance implies the observance of some fundamental rules:

- do not pull on the power cable to disconnect the appliance from the socket;
- do not touch the appliance with wet or damp hands or feet;
- in general the use of adaptors, multiple sockets and extension cables is not recommended;
- in case of malfunction and/or poor operation, switch off the appliance and do not tamper with it.

1.2 Electrical Safety

ENSURE THAT AN ELECTRICIAN OR QUALIFIED TECHNICIAN MAKES THE ELECTRICAL CONNECTIONS. The power supply to which the oven is connected must conform with the laws in force in the country of installation. The manufacturer accepts no responsibility for any damage caused by the failure to observe these instructions. The oven must be connected to an electrical supply with an earthed wall outlet or a disconnecter with multiple poles, depending on the laws in force in the country of installation. The electrical supply should be protected with suitable fuses and the cables used must have a transverse section that can ensure correct supply to the oven.

CONNECTION

The oven is supplied with a power cable that should only be connected to an electrical supply with 220-240 Vac power between the phases or between the phase and neutral. Before the oven is connected to the electrical supply, it is important to check:

- power voltage indicated on the gauge;
- the setting of the disconnecter.

The grounding wire connected to the oven's earth terminal must be connected to the earth terminal of the power supply. See detailed information at page 27.

WARNING

Before connecting the oven to the power supply, ask a qualified electrician to check the continuity of the power supply's earth terminal. The manufacturer accepts no responsibility for any accidents or other problems caused by failure to connect the oven to the earth terminal or by an earth connection that has defective continuity.

NOTE: as the oven could require maintenance work, it is advisable to keep another wall socket available so that the oven can be connected to this if it is removed from the space in which it is installed. The power cable must only be substituted by technical service staff or by technicians with equivalent qualifications.

1.3 Recommendations

After each use of the oven, a minimum of cleaning will help keep the oven perfectly clean.

Do not line the oven walls with aluminium foil or single-use protection available from stores. Aluminium foil or any other protection, in direct contact with the hot enamel, risks melting and deteriorating the enamel of the insides. In order to prevent excessive dirtying of your oven and the resulting strong smokey smells, we recommend not using the oven at very high temperature. It is better to extend the cooking time and lower the temperature a little. In addition to the accessories supplied with the oven, we advise you only use dishes and baking moulds resistant to very high temperatures.

1.4 Waste management and environmental protection



This appliance is labelled in accordance with European Directive 2012/19/EU regarding electric and electronic appliances (WEEE). The WEEE contain both polluting substances (that can have a negative effect on the environment) and base elements (that can be reused). It is important that the WEEE undergo specific treatments to correctly remove and dispose of the pollutants and recover all the materials. Individuals can play an important role in ensuring that the WEEE do not become an environmental problem; it is essential to follow a few basic rules:

- the WEEE should not be treated as domestic waste;
- the WEEE should be taken to dedicated collection areas managed by the town council or a registered company.

In many countries, domestic collections may be available for large WEEEs. When you buy a new appliance, the old one can be returned to the vendor who must accept it free of charge as a one-off, as long as the appliance is of an equivalent type and has the same functions as the purchased appliance.

SAVING AND RESPECTING THE ENVIRONMENT

Where possible, avoid pre-heating the oven and always try to fill it. Open the oven door as infrequently as possible, because heat from the cavity disperses every time it is opened. For a significant energy saving, switch off the oven between 5 and 10 minutes before the planned end of the cooking time, and use the residual heat that the oven continues to generate. Keep the seals clean and in order, to avoid any heat dispersal outside of the cavity. If you have an electric contract with an hourly tariff, the "delayed cooking" programme makes energy saving more simple, moving the cooking process to start at the reduced tariff time slot.

2. Product Description

2.1 Overview

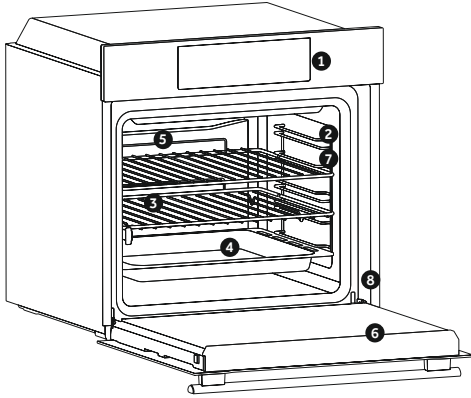

1. Control panel
2. Shelf positions (side racks if included)
3. Wire shelves
4. Roasting dish
5. Fan (if present)
6. Oven door
7. Side racks (if present: only for flat cavity)

2.2 Accessories (according to the model)

Roasting dish

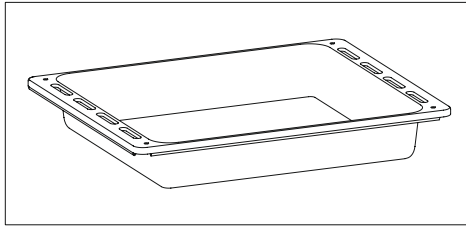

For roasting and grilling. Can be placed on a lower shelf to collect any food drips.

Wire shelf

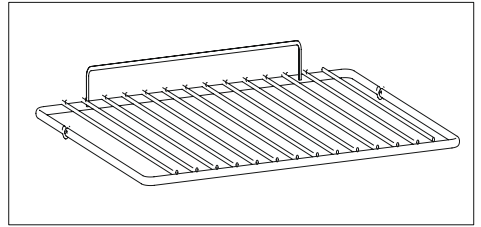

Holds baking trays and plates.

Side racks

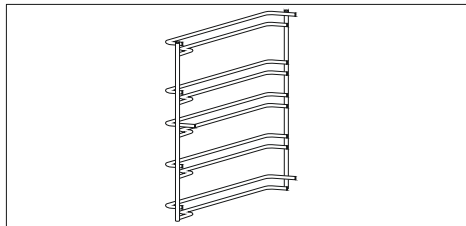

Located on both sides of the oven cavity, holds metal grills and drip pans.

Telescopic guides (only if present)

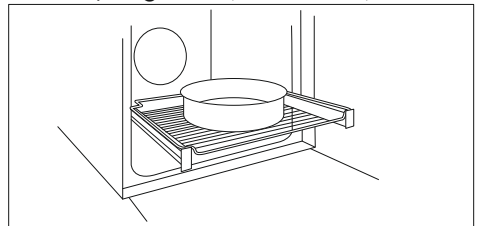

Two guide rails which facilitate the cooking status check as they allow easily the extraction and repositioning of dishes and shelves inside the oven cavity.

2.3 First Use

PRELIMINARY CLEANING

Clean the oven before using for the first time. Wipe over external surfaces with a damp soft cloth. Wash all accessories and wipe inside the oven with a solution of hot water and washing up liquid. Set the empty oven to the maximum temperature and leave on for about 1 hour, this will remove any lingering smells of newness.

3. Use of the Oven

3.1 Display description

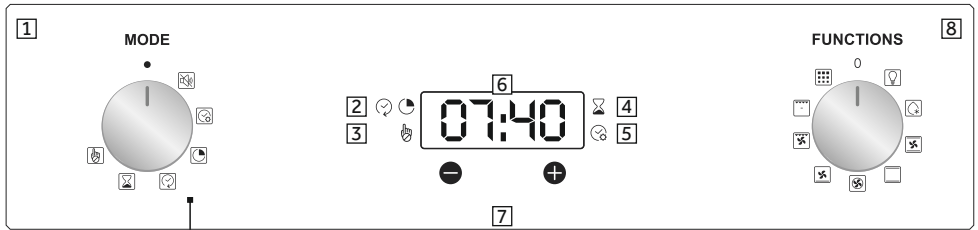







1. Function selector knob
2. Cooking Time/End of cooking
3. Child Safety Lock
4. Minute minder
5. Clock setting
6. Temperature or clock display
7. LCD/temperature adjustment controls
8. Cooking function selector knob









WARNING : the first operation to carry out after the oven has been installed or following the interruption of power supply (this is recognizable by the display pulsating and showing 12:00) is setting the correct time. The bottom right LED flashes at the same time (🕒). This is achieved as follows.

- Rotate the left function selector to the position set the Clock setting.
- Set time with "-" "+" buttons.

ATTENTION: The oven will only operate by setting the clock.

FUNCTION	HOW TO ACTIVATE	HOW TO DEACTIVATE	WHAT IT DOES	WHY IT IS NEEDED
SILENCE MODE 	<ul style="list-style-type: none"> Rotate the left function selector to the position "Silence mode" 	<ul style="list-style-type: none"> Rotate the function selector to the position OFF. 	<ul style="list-style-type: none"> Enables you to turn off the sound of the minute minder. 	<ul style="list-style-type: none"> To turn off the sound of the minute minder
SET THE TIME 	<ul style="list-style-type: none"> Rotate the left function selector to the position "Set the time". Use the buttons "+" or "-" to set the time 	<ul style="list-style-type: none"> Rotate the function selector to the position OFF. 	<ul style="list-style-type: none"> Enables you to set the time which appears on the display 	<ul style="list-style-type: none"> To set the time NB : Set the time when you first install your oven or just after a power cut (the clock is showing a pulsating 12.00)
COOKING DURATION 	<ul style="list-style-type: none"> Turn the right function selector to a cooking function Rotate the left function selector to the position "Cooking Time Duration" Set the time of cooking by using buttons "+" and "-" Lighting Auto appears 	<ul style="list-style-type: none"> When the cooking time has elapsed, the oven switch off automatically and the alarm rings for few seconds To stop the cooking functions early, turn the function control to OFF or set the time on 00.00; by rotating the function selector to Cooking Time Duration and by using the buttons "+" and "-" 	<ul style="list-style-type: none"> It allows to preset the cooking time required for the recipe chosen. When the cooking time is set, turn the function selector to OFF to go back to actual time. To view the cooking time selected, turn the left function selector to Cooking Time duration. 	<ul style="list-style-type: none"> For cooking the desired recipes.
END OF COOKING 	<ul style="list-style-type: none"> Turn the right function selector to a cooking function Rotate the left function selector to the position "End of cooking" Set the end time of cooking by using buttons "+" and "-" Lighting Auto appears 	<ul style="list-style-type: none"> When the cooking time has elapsed, the oven switch off automatically. To stop the cooking functions early, turn the function control to OFF 	<ul style="list-style-type: none"> It allows to preset the end of cooking time you want. When the cooking time is set, turn the function selector to OFF to go back to actual time. To view the cooking time selected, turn the left function selector to End of cooking Time 	<ul style="list-style-type: none"> For example, the desired food needs to cook for 45 minutes and I want it to be ready for 12.30; in this case: at the end of the set time, the oven automatically switches off and an alarm sounds. Select the desired cooking function. Set the cooking duration to 45 minutes ("2" "+""). Set the end of cooking to 12:30 ("2" "+""). Cooking will automatically begin at 11:45 (12:30 minus 45 minutes), at the end of the set cooking time, the oven will automatically switch off. NOTE: Delayed cooking feature is not available for following cooking modes: Fan Grill & Grill WARNING: by setting only the end of cooking time, and not the cooking duration, the oven will immediately switch on and switch off at the end of the set cooking time.
MINUTE MINDER 	<ul style="list-style-type: none"> Turn the left function selector to the position Minute Minder. Set the time of cooking by using buttons "+" and "-" 	<ul style="list-style-type: none"> Set the time on 00.00 by turning the left function selector to the position Minute Minder, and using the button "-" 	<ul style="list-style-type: none"> Emits an audible signal at the end of a set time. During operation, the display shows the remaining time. 	<ul style="list-style-type: none"> Allow to use the oven as alarm even if the oven is switch off
CHILD SAFETY LOCK 	<ul style="list-style-type: none"> Turn the left function selector to the position Child Lock. LED of Child lock will start blinking. Press the button "+" during 7 seconds Child lock is available when LED of Child Lock turn on and "STOP" appears on display 	<ul style="list-style-type: none"> Turn back the left function selector to Child Lock and press button "+" during 7 seconds. Indication STOP disappears and LED of Child Lock starts blink. 	<ul style="list-style-type: none"> The oven cannot be used. 	<ul style="list-style-type: none"> This function is useful when there are children in the house.

3.2 Cooking Modes

Function Dial	T °C default	T °C range	Function <i>(Depends on the oven model)</i>
			LIGHT: Turns on the oven light.
			DEFROST PLUS: When the dial is set to this position, fan circulates air at room temperature around the frozen food so that it defrosts without the protein content of the food being changed or altered.
	180	50 - 240	FAN FORCED: We recommend you use this method for most applications including poultry, pastries, fish and vegetables. Heat penetrates into the food more evenly and both the cooking and preheating times are reduced. You can cook different foods at the same time one or more positions. This cooking method provides even heat distribution. Allow about ten minutes extra when cooking foods at the same time.
	210	50 - 240	FAN BAKE: This function gives better heat distribution thanks to the combination of the fan and heating elements. This function is ideal for bakery such as bread, pizza and focaccia, ensuring an homogeneous cooking result thanks to assisted heat distribution.
	220	50 - 280	BAKE: Both top and bottom heating elements are used. Preheat the oven for about ten minutes. This method is ideal for all traditional roasting and baking. For searing red meats, roast beef, leg of lamb, game, bread, foil wrapped food, flaky pastry. Place the food and its dish on a shelf in mid position.
	210	50 - 230	PASTRY PLUS: The bottom heating element is used with the fan circulating the air inside the oven. This method is ideal for fruit flans, tarts, quiches and pastries. It prevents food from drying and encourages rising in cakes, bread dough and other bottom-cooked food. Place the shelf in the bottom position.
	200	150 - 220	FAN GRILL: use the turbo-grill with the door closed. The top heating element is used with the fan circulating the air inside the oven. Preheating is necessary for red meats but not for white meats. Ideal for cooking thick food items, whole pieces such as roast pork, poultry, etc. Place the food to be grilled directly on the shelf centrally, at the middle level. Slide the roasting tray under the shelf to collect the juices. Make sure that the food is not too close to the grill. Turn the food over halfway through cooking.
	L3	L1 - L5	GRILL: use the grill with the door closed. The top heating element is used alone and you can adjust the temperature. Five minutes preheating is required to get the elements red-hot. Success is guaranteed for grills, kebabs and gratin dishes. White meats should be put at a distance from the grill; the cooking time is longer, but the meat will cook without drying out. Place food on the wire shelf with the roasting dish underneath to catch any drips or directly on to the roasting dish tray.
	ECO	ECO- SUPER	PYROLYTIC SELF-CLEAN

4. Oven cleaning and maintenance

4.1 General notes on cleaning

The lifecycle of the appliance can be extended through regular cleaning. Wait for the oven to cool before carrying out manual cleaning operations. Never use abrasive detergents, steel wool or sharp objects for cleaning, so as to not irreparably damage the enamelled parts. Use only water, soap or bleach-based detergents (ammonia).

GLASS PARTS

It is advisable to clean the glass window with absorbent kitchen towel after every use of the oven. To remove more obstinate stains, you can use a detergent-soaked sponge, well wrung out, and then rinse with water.

OVEN WINDOW SEAL

If dirty, the seal can be cleaned with a slightly damp sponge.

ACCESSORIES

Clean accessories with a wet, soapy sponge before rinsing and drying them: avoid using abrasive detergents.

DRIP PAN

After using the grill, remove the pan from the oven. Pour the hot fat into a container and wash the pan in hot water, using a sponge and washing-up liquid.

If greasy residues remain, immerse the pan in water and detergent. Alternatively, you can wash the pan in the dishwasher or use a commercial oven detergent. Never put a dirty pan back into the oven.

4.2 Pyrolysis

The oven is equipped with a pyrolyser cleaning system, which destroys food residues at high temperature. The operation is carried out automatically by means of the programmer. The resulting fumes are rendered "clean" by passing over a Pyrolyser wick starts as soon as cooking begins. As very high temperatures are required by the Pyrolyser, the oven door is fitted with a safety lock. The pyrolyser can be stopped at any time. The door cannot be opened until the safety lock is displayed.

NOTE : If a hob has been fitted above the oven, never use the gas burners or the electric hot-plates while the Pyrolyser is working, this will prevent the hob from overheating.

TWO PYROLYTIC CYCLE are pre-set:

ECO PYROCLEAN : Cleans a moderately stained oven. Operates for a period of 90 minutes.

SUPER PYROCLEAN : Cleans a heavily stained oven. Operates for a period of 120 minutes.

Never use commercially available cleaning products on a Pyrolytic oven!

Tip : Carrying out Pyrolytic cleaning immediately after cooking allows you to take advantage of residual heat, thus saving energy.

Before executing a pyrolytic cycle:

- Remove all the accessories from the oven because they are not able to tolerate the high temperatures used during the pyrolytic cleaning cycle ; in particular removing grids, side racks and the telescopic guides (refer to the chapter REMOVING GRIDS AND SIDE RACKS) . In ovens with meat probe it is necessary, before making the cleaning cycle , close the hole with the nut provided.
- Remove any large spillages or stains as it would take too long to destroy them. Also excessively large amounts of grease could ignite when subject to the very high temperatures of the Pyrolytic cycle.
- Close the oven door.
- Excess spillage must be removed before cleaning.
- Clean the oven door;
- Remove large or coarse food residues from the inside of the oven using a damp sponge. Do not use detergents;
- Remove all accessories and the sliding rack kit (where present);
- Do not place tea towels.

Using the pyrolytic cycle:



1- Rotate the function selector to the position " " . On the display, appears the indication " ECO " or " SUP ". The preset time is 90 min, this can be varied from 90 min (Eco mode) to 120 min (Sup mode) via the programmer (setting button " + " or " - "). If the oven is very dirty, it is recommend o increase the time to 90 min, if the oven is moderately dirty reduce the cleaning cycle time to 90 min.

2- It is possible to defer the start time of the pyroclean cycle by changing the END time via the programmer.

3- After few minutes, when the oven reaches a high temperature, the door locks automatically. The pyroclean cycle can be stopped at any time by turning the function selector back to '0' (the word OFF will be displayed for 3 seconds).

4 - Once the pyroclean cycle is finished, the pyrolysis will switch off automatically. On the display appears the indication "END" until the door is locked then "0--n".

5- You can turn the function selector back to " 0 " but if the temperaure is still high, the "0--n " indication appears to inform that the door is locked.

Use of the pyrolytic cycle in Touch Control ovens:

1- Rotate the function selector into position pyrolysis. The display will show either "ECO" or "SUP"

2- The pre-set time is 90 minutes but it can be varied from 90 min. (Eco mode) to 120 min. (Sup mode) using the programmer (" + " or " - " key). If the oven is very dirty, the time should be increased to 120 min., while if the oven is only a slightly dirty, reduce the cleaning cycle to 90 min.

4.3 Maintenance

INSTRUCTION FOR REMOVAL AND CLEANING OF THE SIDE RACKS

1. Remove the wire racks by pulling them in the direction of the arrows (see below)
2. To clean the wire racks either put them in the dishwasher or use a wet sponge, ensuring that they are dried afterwards.
3. After the cleaning process install the wire racks in reverse order.

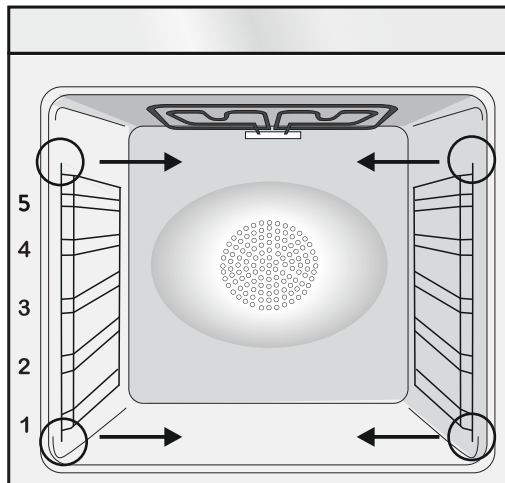

REMOVAL AND CLEANING OF THE DOOR GLASS

1. Open the oven door.

2.3.4. Lock the hinges, remove the screws and remove the upper metal cover by pulling it upwards.

5.6. Remove the glass, carefully extracting it from the oven door (NB: in pyrolytic ovens, also remove the second and third glass (if present)).

7. At the end of cleaning or substitution, reassemble the parts in reverse order.

On all glass, the indication "Low-E" must be legible and positioned on the left side of the door, close to the left-hand lateral hinge. In this way, the printed label of the first glass will be inside the door.

1.



2.

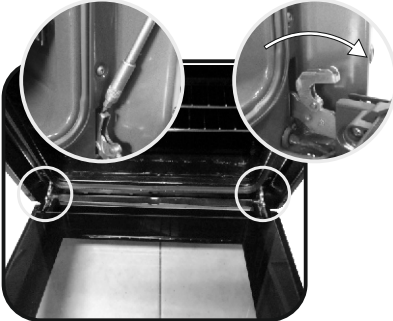

3.

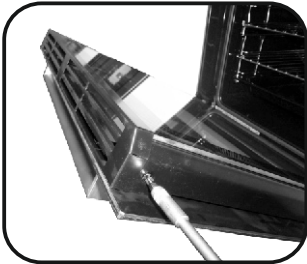

4.

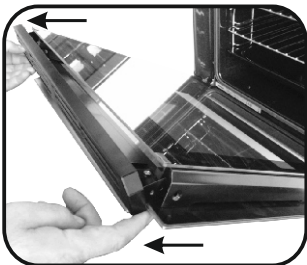

5.

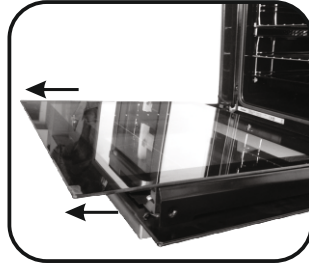

6.

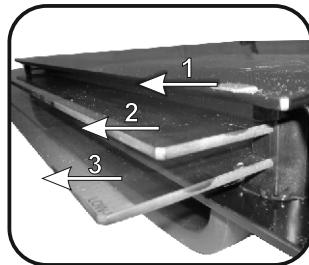

7.

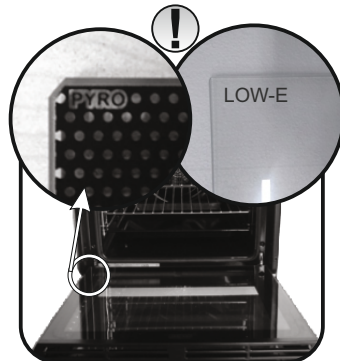

CHANGING THE BULB

1. Disconnect the oven from the mains supply.
2. Undo the glass cover, unscrew the bulb and replace it with a new bulb of the same type.
3. Once the defective bulb is replaced, replace the glass cover.



5. Troubleshooting

5.1 FAQ

PROBLEM	POSSIBLE CAUSE	SOLUTION
The oven does not heat up	The clock is not set	Set the clock
The oven does not heat up	The child lock is on	Deactivate the child lock
The oven does not heat up	A cooking function and temperature has not been set	Ensure that the necessary settings are correct
No reaction of the touch user interface	Steam and condensation on the user interface panel	Clean with a microfiber cloth the user interface panel to remove the condensation layer

Manufacturer's Warranty

Please read this warranty card carefully. Attach your purchase receipt to this warranty card and keep in a safe place. You must produce both warranty card and proof of purchase in the event of a warranty repair being required.

When you purchase any new Haier Product you automatically receive a two year Manufacturer's Warranty covering parts and labour for servicing.

The Manufacturer undertakes to:

Repair or, at its option, replace without cost to the owner either for material or labour any part of the Product, the serial number of which appears on the Product, which is found to be defective within TWO YEARS from the date of purchase.

This warranty DOES NOT cover:

- A Service calls which are not related to any defect in the Product. The cost of a service call will be charged if the problem is not found to be a Product related fault. For example:
 1. Correct the installation of the product.
 2. Provide Instruction on use of the product or change the setup of the product.
 3. Replace house fuses or correct house wiring.
 4. Correcting fault(s) caused by the user.
 5. Noise or vibration that is considered normal.
 6. Water on the floor due to incorrect loading or excessive suds.
 7. Blocked pumps, removal of foreign objects/substances from the machine, including the pump and inlet house filters.
 8. Correcting damage caused by pests, eg. rats, cockroaches etc.
 9. Correct corrosion or discolouration due to chemical attack.
 10. Power outages or surges.
- B Defects caused by factors other than:
 1. Normal domestic use or
 2. Use in accordance with the Product's User Guide.
- C Defects to the Product caused by accident, neglect, misuse or 'Act of God'.
- D The cost of repairs carried out by non-authorized repairers or the cost of correcting such unauthorised repairs.
- E Normal recommended maintenance as set out in the Product's User Guide.
- F Repairs when the appliance has been dismantled, repaired or serviced by other than an AUTHORISED CUSTOMER SERVICE CENTRE or the selling dealer.
- G Pick up and delivery.
- H Transportation or travelling costs involved in the repair when the product is installed outside the AUTHORISED CUSTOMER SERVICE CENTRE'S normal service area.

This product has been designed for use in a normal domestic environment. It is not intended for commercial use. Doing so may affect product warranty.

Service under this warranty must be provided by an Authorised Service Repairer (refer to the Customer Care section for contact details). Such service shall be provided during normal business hours. This warranty certificate should be shown when making any claim.

Note:

This Warranty is an extra benefit and does not affect your legal rights and applies only to product purchased in New Zealand and Australia. **Please keep this Warranty Card in a safe place.**

For Australian customers:

Our goods come with guarantees that cannot be excluded under the Australian Consumer Law. You are entitled to a replacement or refund for a major failure and for compensation for any other reasonably foreseeable loss or damage. You are also entitled to have the goods repaired or replaced if the goods fail to be of acceptable quality and the failure does not amount to a major failure.

Customer Care

Check the things you can do yourself.
Refer to your User Guide and check:

- 1 Your appliance is correctly installed.
- 2 You are familiar with its normal operation.
- 3 You have read the problem solving section in your User Guide.

If after checking these points you still need assistance, please refer to your nearest Haier Authorised Repairer.

In New Zealand, if you need assistance...*

Call your retailer who is trained to provide information on your appliance, or if we can be of any further help, please contact our Customer Care Centre:

Toll Free: 0800 242 437 **Fax:** (09) 273 0656

Email: customer.care@haier.co.nz

Postal address: P.O. Box 58732, Botany, Manukau 2163

If you need service...*

We have a network of independent Fisher & Paykel Authorised Repairers whose fully trained technicians can carry out any service necessary on your appliance. Your dealer or our Customer Care Centre can recommend a Fisher & Paykel Authorised Repairer in your area.

In Australia, if you need assistance...*

Call the Customer Care Centre and talk to one of our Customer Care Consultants.

Toll Free: 1300 729 948 **Fax:** (07) 3826 9298

Email: customer.care@haierlife.com.au

Postal Address: PO Box 798, Cleveland QLD 4163

If you need service...*

We have a network of qualified Authorised Repairers whose fully trained technicians can carry out any service necessary on your appliance. Our Customer Care Centre can recommend an Authorised Repairer in your area.

*If you call or write, please provide: name, address, model number, serial number, date of purchase and a description of the problem. This information is needed in order to better respond to your request for assistance.

Product Details

Model	HWO60S8EPB2 HWO60S8EPX2	Serial No.	-----
Date of Purchase	-----	Purchaser	-----
Dealer	-----	Suburb	-----
Town	-----	Country	-----

Thank you for choosing Haier. We are confident that you will enjoy many years of good service from your appliance.

Installation

Installation must be done according to instructions by a qualified technician. Manufacturer is not responsible for any damages caused by incorrect installation.

The oven can be located high in a column or under a worktop. Before fixing, ensure that the ventilation holes are present as shown below.

Always ensure there is an opening for the power supply cable.

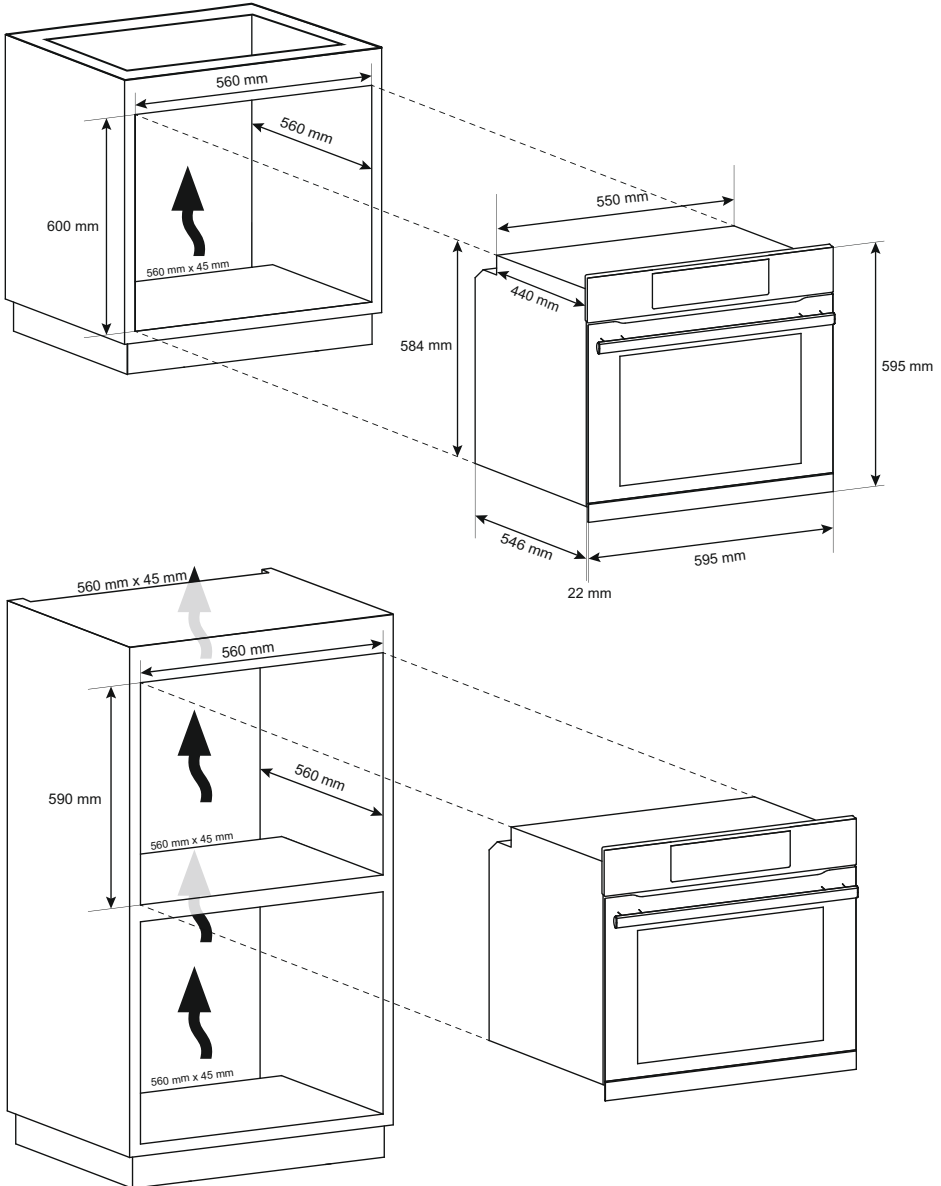

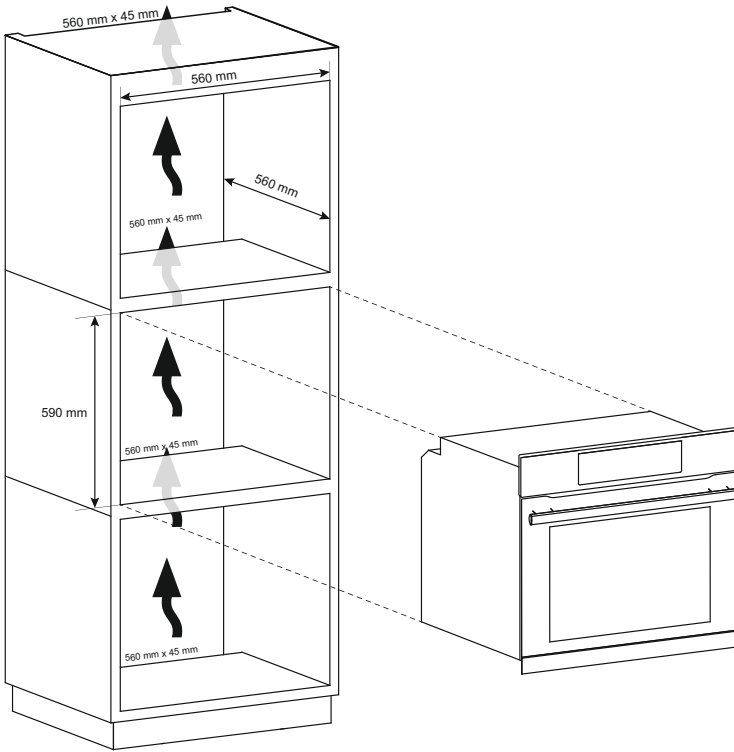

Electrical Connections

- The appliance may be connected to the mains supply only by a competent person.
 - The mains lead must not be clamped, bent, trapped, or come into contact with hot parts of the appliance.
 - This oven must be earthed.
- Before connecting the oven to the mains power supply, check that:
- The domestic wiring system is suitable for the power drawn by the oven (as specified on the rating plate)
 - The voltage corresponds to the value given on the rating plate.

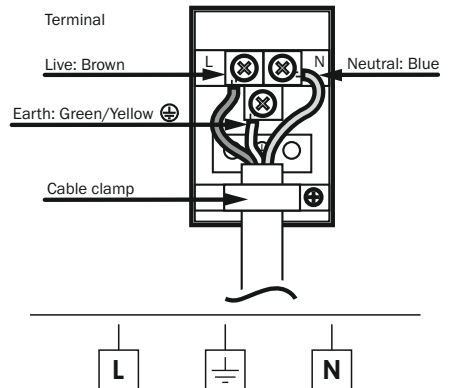

Model	Max Power (W)	Frequency (Hz)	Voltage (V)	Amps (A)
HWO60S8EPB2	3400 W	50 / 60 Hz	220 - 240 ~	14.1 - 15.5
HWO60S8EPX2				

Important Installation Instructions

Control Panel Moisture Seal



Moisture tray must be fitted when installing oven under a worktop.

Follow your installation manual for all other aspects of oven installation

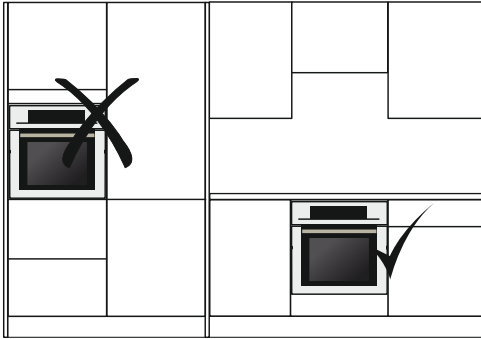

Not required for ovens in a tower configuration.

1

Clean the top of the oven panel.

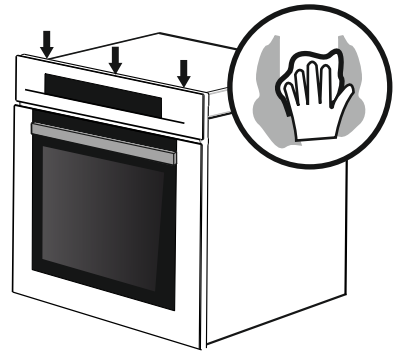

2

Peel the adhesive layer off the moisture tray.

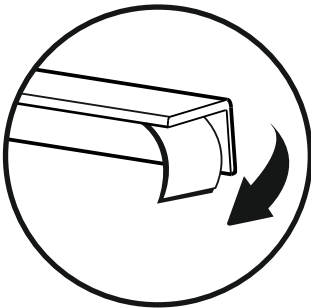

3

Fit the moisture tray to the control panel as shown.

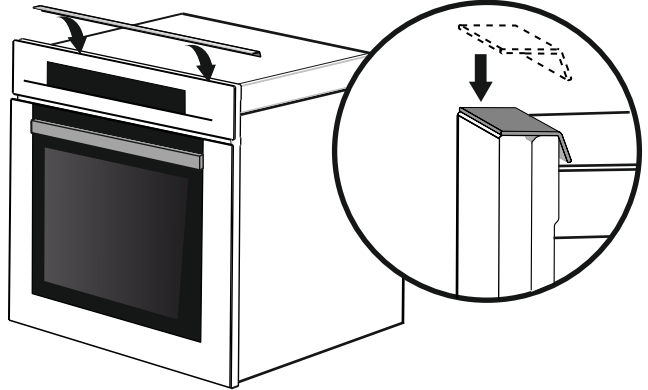

EN CAUTION: When installing appliance beneath the worktop, the seal must be fitted as indicated.

Clean and degrease the surface beforehand and check its proper positioning after installation beneath the worktop.

EN

The manufacturer will not be responsible for any inaccuracy resulting from printing or transcript errors contained in this brochure. We reserve the right to carry out modifications to products as required, including the interests of consumption, without prejudice to the characteristics relating to safety or function.



7 0008544 • A5 • 11.2021 • Rev_0