

# USER MANUAL

ELECTRIC SMART TOILET SEAT

Model: KARE-659G

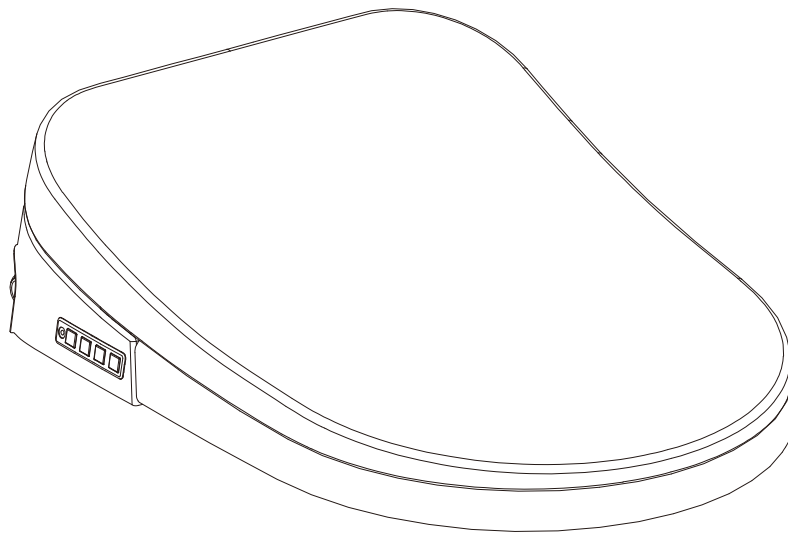

Edition: V 2021.10.06  
Area: Australia, New Zealand

Dear customers,

Thank you for purchasing our intelligent toilet series products, to ensure safety before using this product, please read this instruction carefully and keep it carefully for reference.

<b>Names of each part -----</b>	<b>02</b>
<b>Remote control user manual -----</b>	<b>04</b>
<b>Product technical parameters -----</b>	<b>06</b>
<b>Product function description -----</b>	<b>07</b>
<b>Product installation methods -----</b>	<b>09</b>
<b>Product use method -----</b>	<b>13</b>
<b>Precautions for use -----</b>	<b>14</b>
<b>Product cleaning and maintenance methods -----</b>	<b>17</b>
<b>How to deal with common problems -----</b>	<b>20</b>

**Warning:** This douche seat must be installed with appropriate backflow conforming to the national construction code volume three.

# 1、 Names of each part

## Machine body

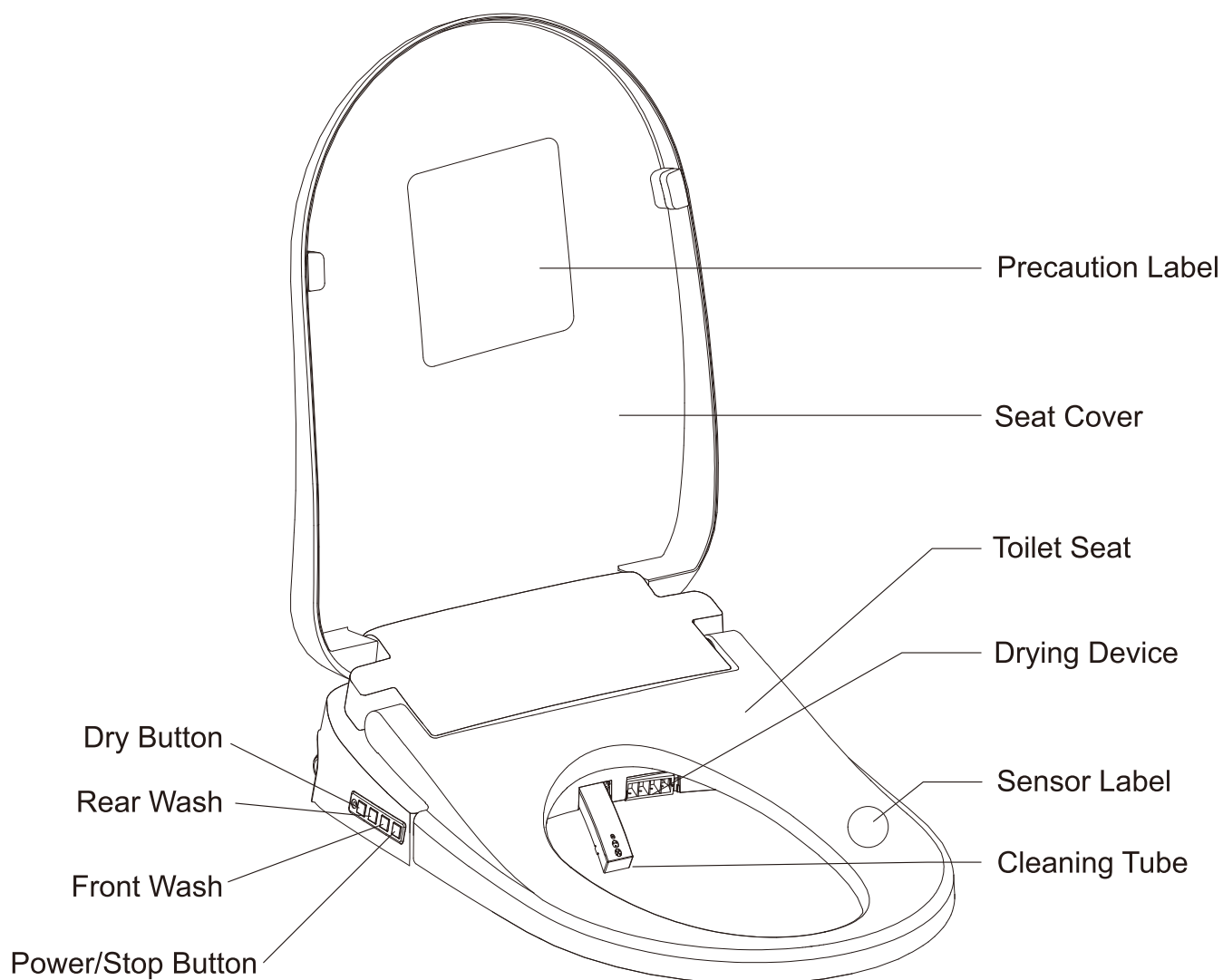
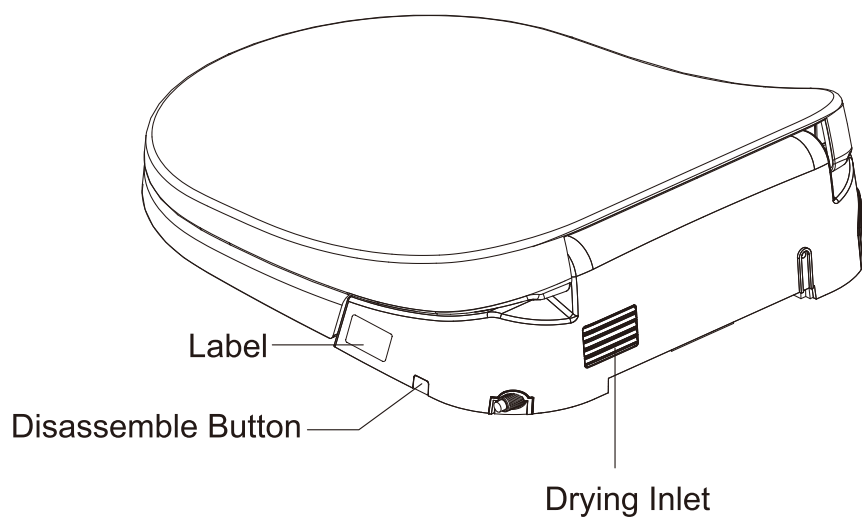

• The actual appearance and function are based on the material object.

**Parts:**



Two M5\*50 screws

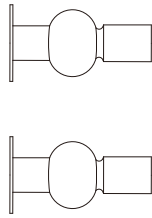

Two expansion screws

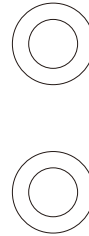

Two round gaskets



Two square gaskets

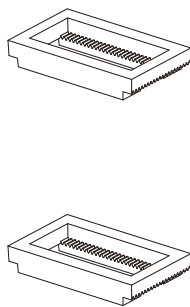

Two fixed guide plates

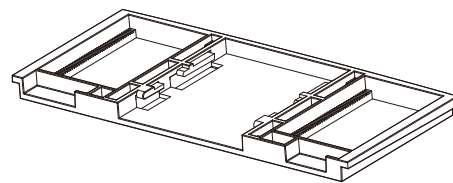

Fixed plate  
(From back of cover plate, press and hold the right button and push out the fixed plate)

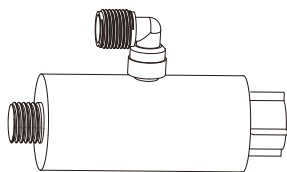

Water filter

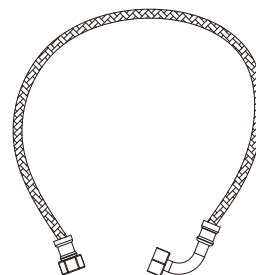

Water supply pipe

- The appearance and accessories should be based on real objects.



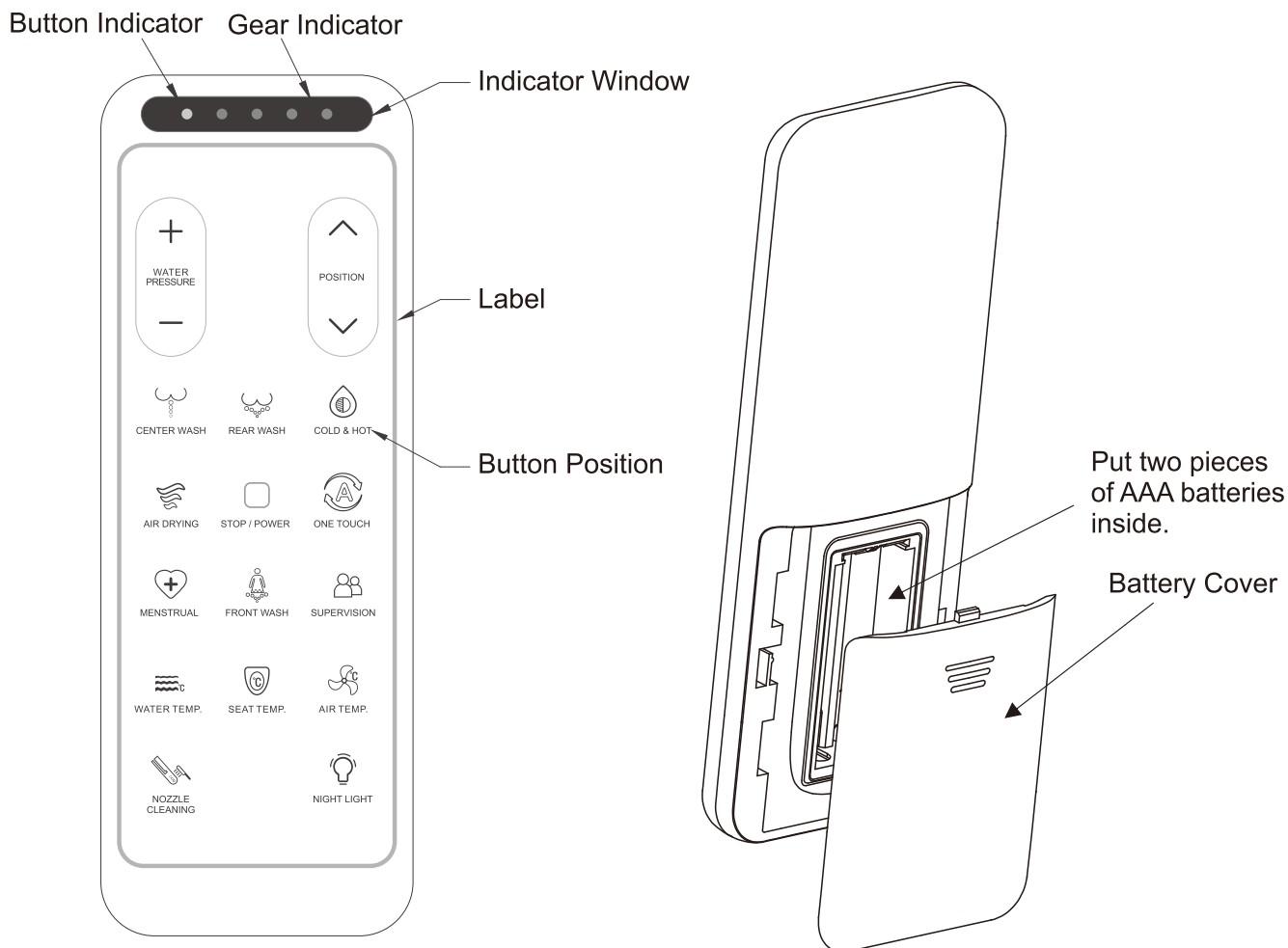

## 2、 Remote control user manual









### Remote control code matching steps:

1. Power off the bidet,
2. Press and hold STOP/POWER and NOZZLE CLEANING buttons simultaneously for about 2 seconds , until the 4 indicator lights are turned on and flashing.
3. Turn on the bidet
4. When the remote control is connected to the bidet , the third and fourth indicator lights will be on, it means code matching succeeded. If not succeeded , try again after 15 seconds.







### (1) Main function

 <p><b>Rear Wash</b> Short press: start wash buttocks. Double press: start / stop mobile wash.</p>	 <p><b>Warm Air Drying</b> Short press: start warm air drying.</p>
 <p><b>Front Wash</b> Short press: start female wash. Double press: start / stop mobile wash.</p>	 <p><b>Stop Current Work</b> Short press: quit current wash or drying. Long press: turn the toilet power on or off.</p>

## (2) Parameter adjustment

<p>  Adjust water pressure            Short press "+", water pressure grade +1,            short press "-", water pressure grade -1.         </p> <p>  Adjust tube front and rear position.            Short press "^", tube position grade +1,   short press "v", tube position grade -1.         </p>	<p>  Adjust seat temperature            Short press: cyclically adjust seat temperature.         </p> <p>  Adjust water temperature            Short press: cyclically adjust water temperature.         </p> <p>  Adjust air temperature            Short press: cyclically adjust air drying temperature.         </p>
----------------------------------------------------------------------------------------------------------------------------------------------------------------------------------------------------------------------------------------------------------------------------------------------------------------------------------------------------------------------------------------------------------------------------------------------------------------------------------------------------------------------------------------------------------------------------	-----------------------------------------------------------------------------------------------------------------------------------------------------------------------------------------------------------------------------------------------------------------------------------------------------------------------------------------------------------------------------------------------------------------------------------------------------------------------------------------------------------------------------------------------------------------------------------------

## (3) Auxiliary functions

<p>  One-touch completes rear wash and warm air drying.            Short press: start automatic "One Touch" mode.         </p> <p>  Defecation clean: clean water column shoots into the end of the anorectal to help defecation.            Short press: start defecation clean.         </p> <p>  Supervision: customized the appropriate parameters for children, wash the buttocks.            Short press: start children care cleaning.         </p> <p>  Menstrual: Cleaning the genitals with customized parameters during woman's menstrual period.            Short press: start menstrual care wash.            Double press: turn mobile cleaning on or off.         </p>	<p>  Cold &amp; Hot SPA: water alternately massages and washes.            Short press: start cold &amp; hot massage.            Press continuously: turn mobile cleaning on or off.         </p> <p>  Night light during night            Short press: turn night light on or off.            Press continuously: enter or exit energy saving mode.         </p> <p>  Nozzle cleaning: when not seated, stick out the nozzle for daily cleaning.            Short press: start nozzle cleaning.         </p>
---------------------------------------------------------------------------------------------------------------------------------------------------------------------------------------------------------------------------------------------------------------------------------------------------------------------------------------------------------------------------------------------------------------------------------------------------------------------------------------------------------------------------------------------------------------------------------------------------------------------------------------------------------------------------------------------------------------------------------------------------------------------------------------------------------------------------------------------------------------------------------------------------------------------------------------------------------------------------------------------------------------------------------------------------	----------------------------------------------------------------------------------------------------------------------------------------------------------------------------------------------------------------------------------------------------------------------------------------------------------------------------------------------------------------------------------------------------------------------------------------------------------------------------------------------------------------------------------------------------------------------------------------------------------------------------------------------------------------------------------------------------------------------------------------------------------------------------------------

## (4) Others

### Energy saving

After the user leaves the seat, intelligently adjust the heating power of the seat.

## Remote control installation steps

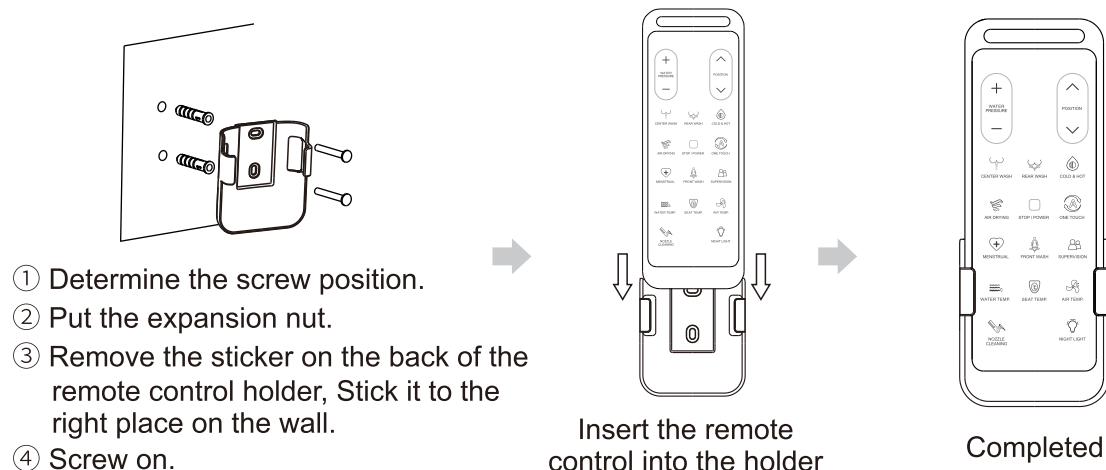

### 3、Product technical parameters

Names		Smart Toilet Seat	
Rated voltage		220-240V~	
Rated frequency		50Hz	
Rated power		1350W (15°C±1°C inlet water temperature)	
Power cord length		1.5m	
Water supply mode		Directly connected to the channel	
Ambient temperature		About 0°C to 40°C	
Water supply temperature		About 3°C to 35°C	
Water pressure range		0.08MPa-0.75MPa	
Safety devices		Seated sensor, water over-pressure protection device	
Decontaminating apparatus	Heating method		Instant heating
	Warm water temperature		Four grades (About 34°C to 40°C)
	Spray volume	Buttock cleaning	About 0.5 to 0.8L/min
		Women-only	About 0.5 to 0.8L/min
	Warm water heater		1600W
	Safety applause		Temperature sensor, temperature fuse, temperature jumper, flowmeter
Drying device	Wind speed		>4m/s
	Air temperature		Four grades(Room temperature to 50°C)
	Drying heater		250W
	Safety devices		Double-sheet-metal switch, temperature fuse
Deodorizing device	Method		Activated carbon
	Power consumption		1.5W
Thermal seat	Seat temperature		Four grades(Room temperature to about 40°C)
	Seat heater		35W
	Safety devices		Temperature sensor, temperature fuse
	Switch structure		Seat and cover with damping slow down device Type III: gear case clamshell

- Notes: 1. Wind temperature is measured near the warm wind outlet.  
2. When water pressure is less than 0.08MPa, it is recommended to install booster pump. Otherwise it may affect your normal use.

## 4、 Product function description

### **The seating induction**

The system is equipped with human body induction sensor, and only after the induction of human body sitting, then the function of cleaning or drying can be carried out.

### **Automatic deodorization**

When the system detects the human body sitting, the deodorant fan will automatically turn on and continue working for 3 minutes after the human body leaves the seat then automatic shutdown.

### **Turn off deodorant manually**

If you want to turn off the deodorization function during use, press the "stop button" once in the state of non-cleaning and drying, then you can turn off deodorant manually.

### **Energy saving mode**

If the energy saving mode is turned on when the seat is being touched, the energy saving mode will be carried out by a delay of 3mins after leaving the seat. Open the energy-saving mode when leaving the seat then immediately carry out the energy-saving mode. After entering the energy-saving mode, the heating power of the seat will be intelligently adjusted.

### **Rear Wash**

Clean the buttocks.

### **Front Wash**

Clean the female genitals.

### **Warm Air Drying**

Dry the buttocks with warm air.

### **Defecation Clean**

A column of clean water is pumped into the end of the anus to help defecation.

### **Supervision**

Wash buttocks with appropriate parameters customized by children.

### **Cold And Hot SPA**

Cold and hot water alternately washes the anus or perineum.

### **Nozzle Cleaning**

When not seated, stick out the nozzle for daily cleaning.



## One Touch

One key automatically completes buttocks cleaning and warm air drying.

## Defecation Clean

A column of clean water is pumped into the end of the anus to help defecation.

## Supervision

Wash buttocks with appropriate parameters customized.

## Cold And Hot SPA

Cold and hot water alternately washes the anus or perineum.

## Menstrual Deep Care

Clean the pudenda with customized parameters of female menstruation.

## Nozzle Cleaning

When not seated, stick out the nozzle for daily cleaning.

### Side button function description

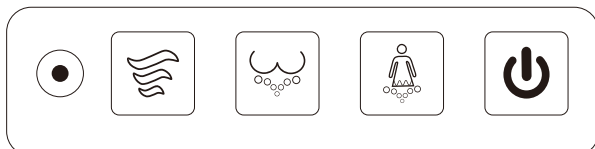

#### Standby Model

By pressing the power button on the control panel.  
Short touch: stop washing or drying model.  
Long press: start or stop standby model when it's in off seat model.



#### Front Wash

Touch Front wash button when you are in seat, and start washing process.



#### Dry Button

Touch air drying button when you are in seat, and start washing process. It's off in 4 minutes.



#### Rear Wash

Touch rear wash button when you are in seat, and start washing process.

## 5、 Product installation methods

### ① Precautions before installing the toilet

1. This product uses the 220-240V~ voltage, electrical construction requires the commission of professional electrical companies.
2. When using this product, tap water pressure must be 0.08Mpa - 0.75Mpa.
3. After the installation, plug the product power into the socket. When you hear a "D", it means that the product is powered on and the self-test is completed;
4. Please use the water supply pipe attached to the toilet for installation. Do not use the old water supply pipe, otherwise it may affect the performance of the product;
5. Please do not use cloth cover or cushion on the seat, otherwise it may cause seat induction not good.
6. In low-temperature environment, please leave the product in a warm room for 2 hours before installation to prevent internal moisture from damaging the machine.
7. The following picture shows the toilet standard specifications of the product that can be installed.

### Product dimensions

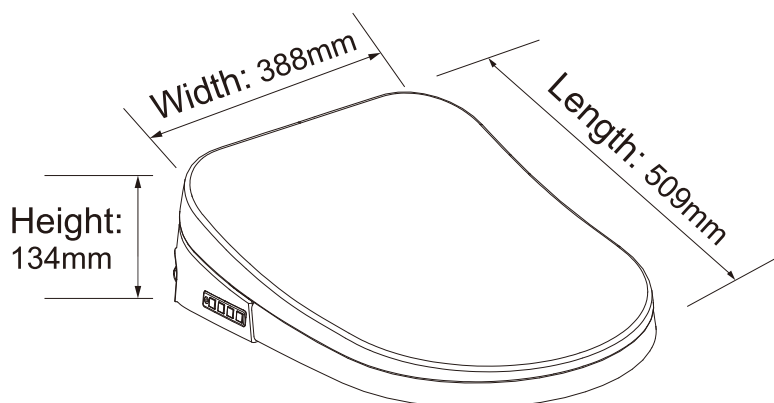

### Dimensions of the toilet that can be installed

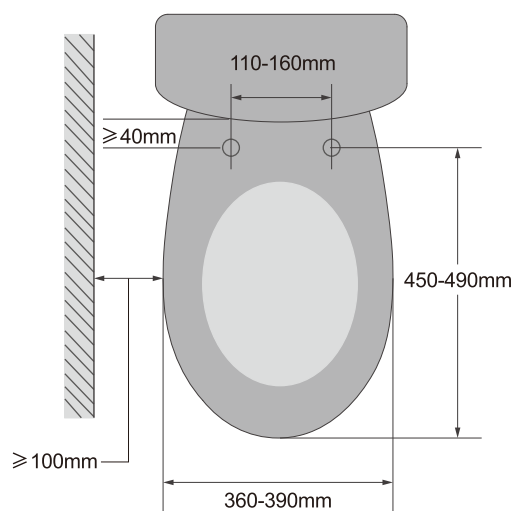

- This series toilet seat cover not suitable for children-toilet and arch water-tank toilet (as below pictures shown)

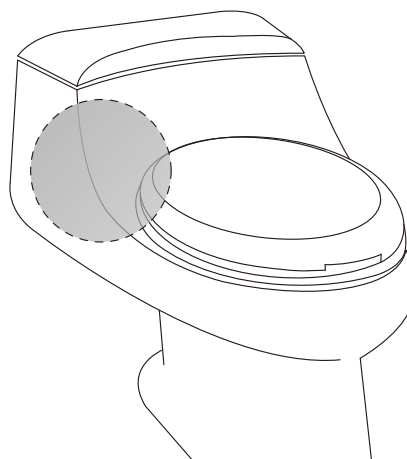

Installable water supply valve

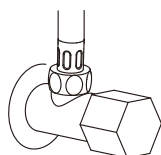

One-piece water tank rear arch toilet

## ② The method of separating the installed toilet seat and fixed water purification filter.

1. Turn the hose valve (supply stop) to the right and lock it, and then separate the water tank from the water pipe valve (supply stop) with the water supply pipe.

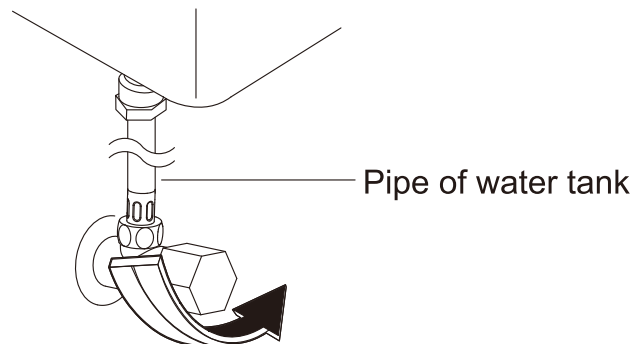

2. Detach the installed toilet seat.  
(Disassemble the product according to the original method of toilet seat.)

• Take proper care of seat cover, bolt, nut seal. They will be needed when moving or reinstalling.

3. Connect the water purification filter to the water pipe valve (supply stop), and then separately connect the water tank and the seat water supply pipe to the assembled water purification filter.

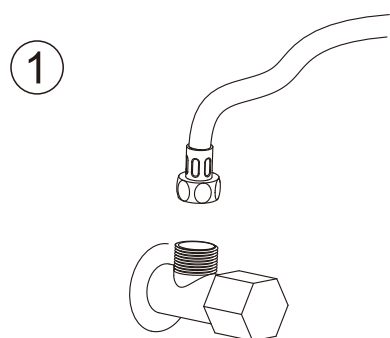

Separated water tank supply pipe and water pipe valve.

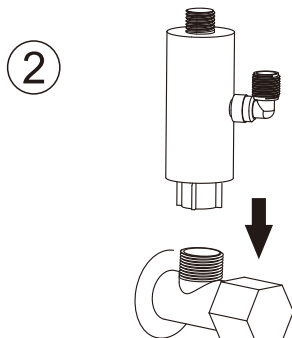

Water pipe valve connected to water purification filter.

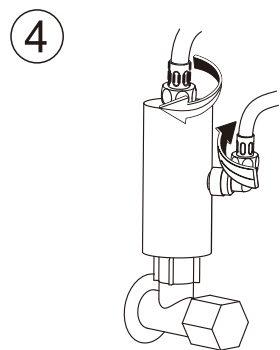
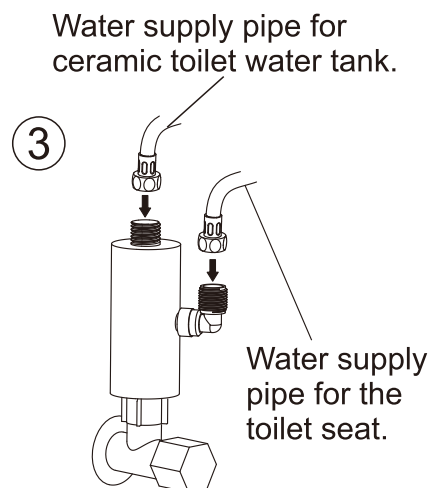

Water supply pipe connected to the filter purification.

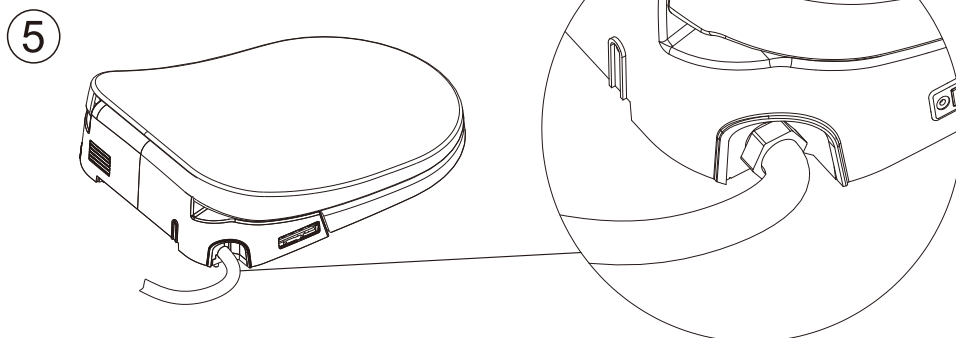

Water supply pipe is connected to toilet.

### ③ Fixing method of fixed plate and intelligent toilet

1. Insert expansion screw into toilet seat holder. Place mounting plate on toilet seat. Stainless steel screws are threaded in turn Square gasket, moving fixed plate, fixed on the installation plate fixed plate, the installation plate fixed plate fastening on the toilet.

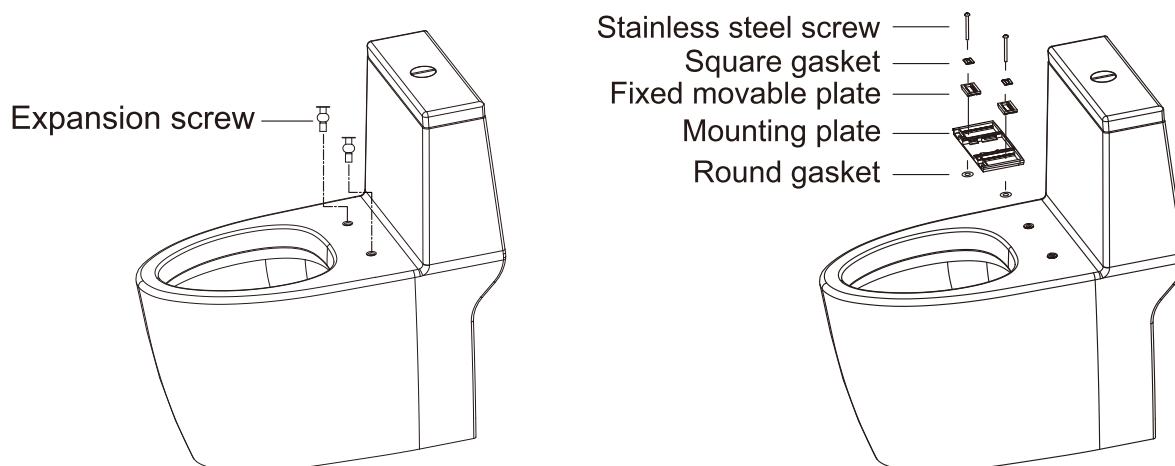

2. Insert the mounting plate assembly into the center of the rear of the smart toilet seat cover. If there is “click” sound, it is in normal installation state.

- Do not flip the toilet during operation.

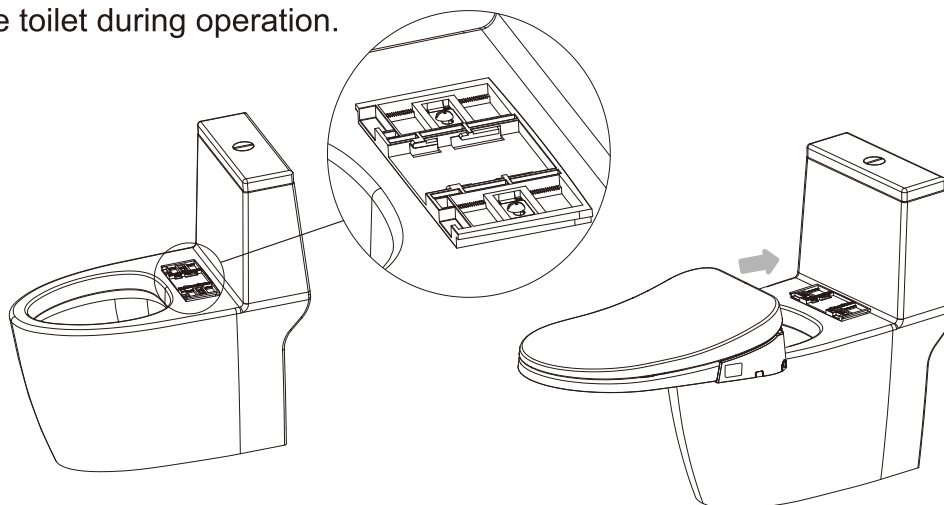

3. Sway the smart toilet seat cover back and forth, and left and right to check whether it will come off.

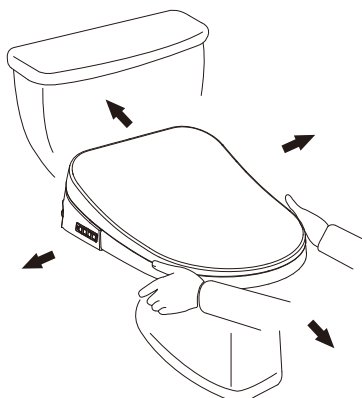

### ④ Smart toilet disassembly method

Press the removal button on the side of the smart toilet and pull the product forward in this state, then the toilet is separated from the seat.

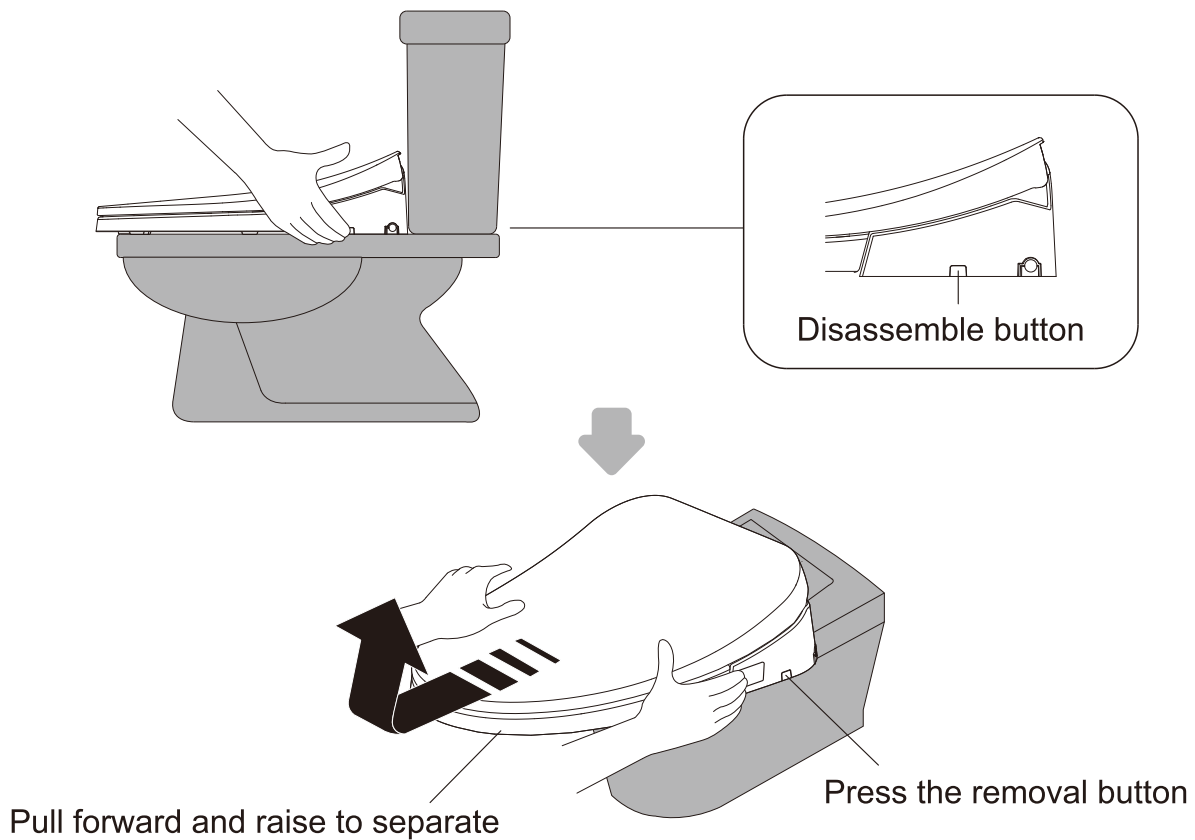

### ⑤ Instruction for testing after installation

After the installation is complete, it must be commissioned and record the results of the installation points in the following form.

Check items				Results
Is it connected to the 220-240V~, 10A, 50Hz power outlet? Grounding the equipment is required.				
Is the power outlet loose?				
Is the water supply opened?				
Tighten the various joints (such as the filter, water supply pipes and screw, etc) ?				
Is the indicator light on?				
The spraying nozzle is leaking? After wiping the nozzle, check if there is any water leakage.				
<b>The various functions of the product is normal:</b> Rear wash and front wash, water temperature and seat temperature adjustment, cold & hot SPA, soft lighting and nozzle cleaning, etc. Are they normal use? The above series of actions should be checked.				
<b>Date of installation</b>		<b>Name of the installation store</b>	<b>Installer</b>	

## 6、 Product use method

### For the first time, debugging the machine

#### 1. Check the power

Insert the plug into a good grounding socket, make sure plug is tight.

#### 2. Human body sensing (Figure 1)

Only in the seated state, cleaning function and drying function can be normally executed.

#### 3. Discharge the air inside the machine (Figure 2)

When using it for the first time, please touch the sensor label area with your hand, or place a wet tissue on the sensor label area. Smooth out the toilet bag on the seat lid and press the rear wash button, so that the toilet enters the cleaning mode.

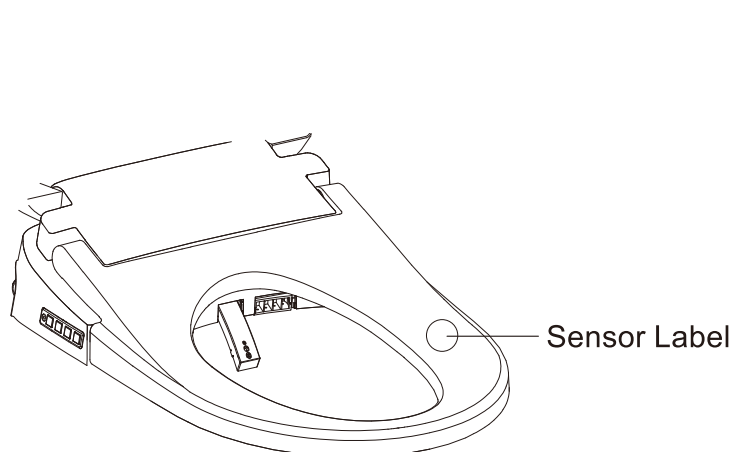

(Figure 1)

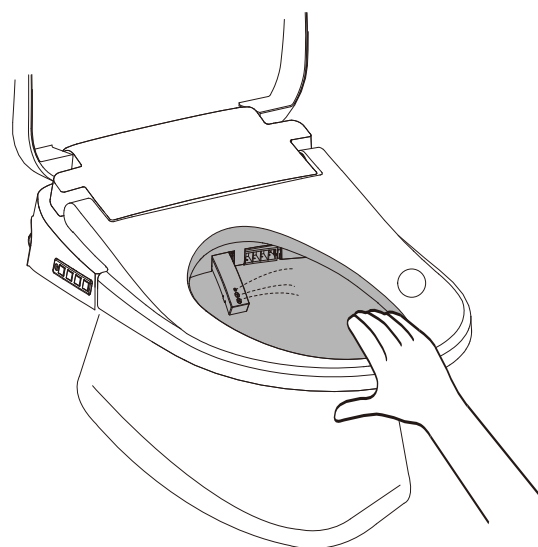

(Figure 2)

#### 4. Check the cleaning function

In the seated state, press the rear wash, front wash and other washing functions. During washing, check the water temperature, water pressure and nozzle position adjustment is normal.

#### 5. Check the drying function

In seated state, enter the drying function, during the drying process, check the air temperature adjustments is normal.

#### 6. Check deodorant function

In the seated state, check whether the deodorizing fan works.

## 7、 Precautions for use





### **! WARNING**

Installation can only be conducted by an authorized licensed plumber in accordance with NCC Part Three (PCA) and utilizing appropriate high-hazard cross connection control.

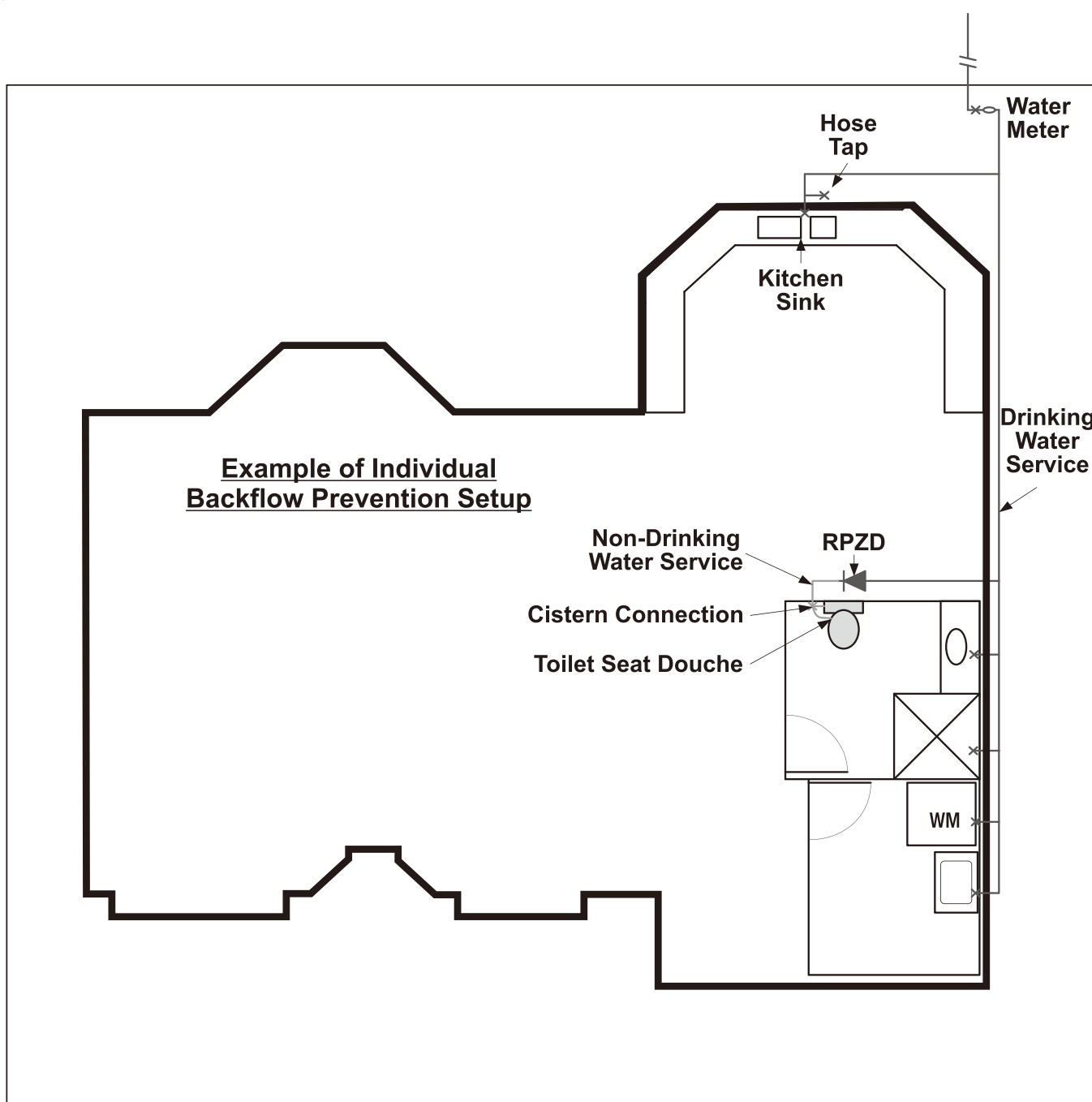





**WARNING:** This product utilizes low-hazard backflow protection devices which comply with AS/NZS 2845.1. According to NCC Part Three (PCA), WMTS-051:2020, and AS/NZS 3500.1, this product must be installed in conjunction with a high-hazard backflow protection device (not supplied). We recommended for a Reduced Pressure Zone Device (RPZD) to be installed externally, as shown in the figure below.





 <b>Attention</b>	It may cause minor injury or damage, be sure to always pay attention.
 <b>Forbiddance</b>	Do not operate forbidden content.
 <b>Enforcement</b>	Must comply with the enforcing content.
 <b>Ground</b>	Ground wire connection is correct, firing line, zero line, ground.

## Warnings

 <b>Do not disassemble</b>	It is absolutely forbidden to disassemble, repair and transform this product by yourself. It may cause fire, electric shock and other accidents.
 <b>No watering</b>	Do not pour water or detergent on the power plug. It may cause fire, electric shock and other accidents.
 <b>Forbiddance of fire</b>	Do not bring lit cigarettes or burning species close to the product. It may cause a fire.
 <b>Forbiddance</b>	Please do not continue to use the product when the product fails. Please contact the after-sales service staff for maintenance. When the following situation occurs, please remove the power plug and close the inlet angle valve. 1. Leakage from the inside of the product line; 2. The product is unusually hot; 3. The product makes an abnormal sound and smell; 4. The product is burnt. If the product is still used in the event of malfunction, it may cause problems such as fire, electric shock, water inflow in the room. (The normal life of this product is six years, the continued use beyond the service life may lead to accidents.)
	Only tap water can be used. Otherwise may cause infectious dermatitis and other diseases.
	Do not use loose power outlet. It may cause a fire or electric shock.
	When the toilet is opening the seat or cover, the opposite force exerted by man or other external forces is prohibited.
	Please use the power outlet within the specified conditions (220-240V~, 10A, 50Hz socket). Do only use 220-240V~ power supply. Using power beyond the socket regulations may cause the socket to heat up and cause a fire.
	Do not damage the power cord and seat wire. 1. Do not damage, do not process, do not heat; 2. Do not force bending, do not curly tied, do not pull; 3. Do not put heavy objects on the power cord and the seat lid connection, ignoring product damage and continuing to use may result in fire, electric shorts and other conditions.
 <b>Enforcement</b>	1. This product belongs to the electrical products, do not put it in places where there is water or the places of high humidity. When used in the bathroom, please install ventilation fan or ventilation port to keep the bathroom in good air circulation. Otherwise, it may cause a fire or electric shock. 2. If the power cord is damaged, do not disassemble it yourself and must be replaced by the manufacturer or its service department or relative department.



 <b>Grounding</b>	<p>Please check if grounding is done. A product that is not grounded may cause an electric shock in the event of a malfunction or leakage.</p>
-------------------------------------------------------------------------------------------------------	----------------------------------------------------------------------------------------------------------------------------------------------------

<b>Attention</b>	
 <b>Forbiddance</b>	<p>Forbiddance sitting on the seat for a long time, the seat temperature should be adjusted in low-grade, please note that low-temperature burns. The following personnel should set the seat temperature at low-grade when using the toilet. 1. Supervision and elderly people who cannot adjust the temperature to the right degree, 2. Patients, persons with disabilities and other people who can not move freely, 3. Lethargic crowd because of taking hypnotics (Such as sleeping pills, cold medicine, etc.) deep drinking and over fatigue.</p>
	<p>Do not forcibly stretch the connecting pipe of the water supply pipe. Otherwise it may cause water leakage.</p>
	<p>Defecation clean function, a special cleaning function, only allowed to use one time whenever you use the toilet, non-repeated use!</p>
	<p>Do not rely on the seat cover or forcibly press the control panel. Otherwise it may result in malfunction or breakage. Forced application of force may cause seat cover and control panel damage, resulting in personal injury.</p>
	<p>Do not place containers containing liquid such as vials, cups, cosmetics, pharmaceuticals, etc. or small metal objects on top of the product. Inadvertent entry into the product may result in fire or electric shock.</p>
	<p>Do not place the product in direct sunlight, otherwise the appearance of products may be aging deformation.</p>
	<p>People with disabilities, mental retardation, etc. (including children) need to use this toilet under supervision, do not let children play with this toilet.</p>
	<p>Do not use the toilet to flush expect shit, urinate and toilet paper, or it may cause toilet jam, sewage overflow.</p>
	<p>Please do not hit the ceramic to prevent damages that result in leakage.</p>
 <b>Enforcement</b>	<p>When installing the inlet angle valve, please tighten firmly. Otherwise it will lead to water leakage.</p>
	<p>Prevent damage caused by freezing. Freezing can cause damage to the water hose and product interiors and cause water leakage.</p>
	<p>When traveling for long periods of time or when not in use, please unplug the power plug from the outlet.</p>
	<p>Unplug the power plug when lightning occurs.</p>
	<p>This product is only for bathroom, and should not be used for any purposes other than the ones described in this manual. Otherwise maybe cause to fire, electric shock, personal injury or malfunction.</p>
	<p>Do not allow urine and other contaminants to touch the smart toilet. Doing so may cause odor or cause malfunction.</p>
	<p>Do not forcibly close the seat and seat cover. It is necessary to avoid the collision of the seat lid and the seat cover when turning them. Otherwise maybe cause malfunction. Don't clip to the fingers while seat and seat cover switch, otherwise maybe cause bruise.</p>
	<p>For external maintenance, unplug the power plug from the socket for safety reasons. Otherwise maybe get an electric shock.</p>

## 8、 Product cleaning and maintenance methods

### Warning: waterproof toilet cleaning precautions

- Do not clean the product with your hands in case of damage or failure, to avoid secondary failure.
- Do not use hydrochloric acid detergent, thinner, bleach, benzene or strong detergent to clean the surface of the toilet.  
Do not allow pesticides, air fresheners and deodorants to stick to the toilet bowl.
- **The body discoloration, cracking and damage caused by the use of the above-mentioned reagents, even within the warranty period also need to paid the services.**

### ① Nozzle cleaning

1. On the machine power mode, do not sit on the seat.
  2. Press "Nozzle cleaning", entering the manual cleaning nozzle mode.  
(Can not activate "nozzle cleaning" mode when seated)
  3. Please use soft brush or soft cloth when cleaning.
  4. After the cleaning is completed, press the stop button or in the seating state, the cleaning tube is automatically retracted.
- **Warning: do not force out or push into the cleaning tube during cleaning, or it may lead to machine failure.**

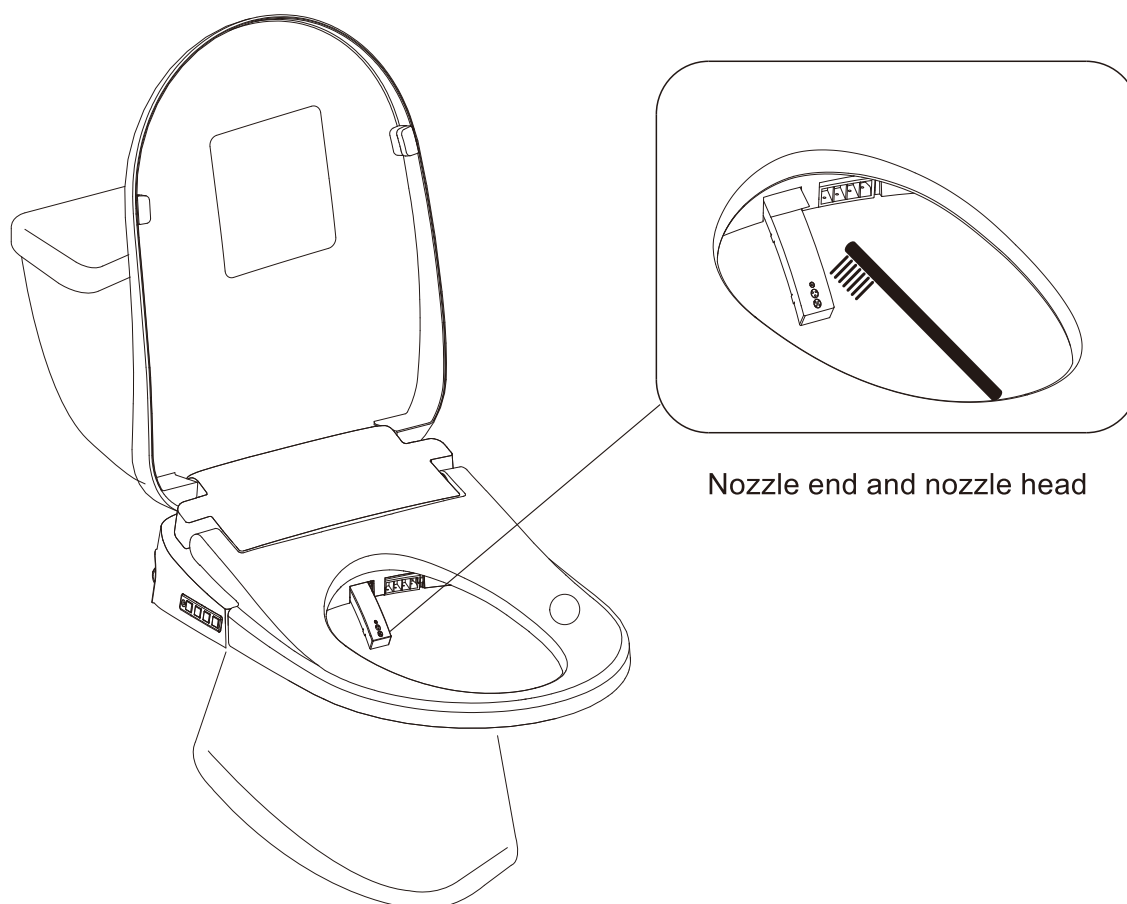

## ② Toilet appearance cleaning method

**Clean the toilet when the toilet is in fixed state.**

1. Please use sponge or soft cloth stained with neutral detergent to clean the surface of the toilet.

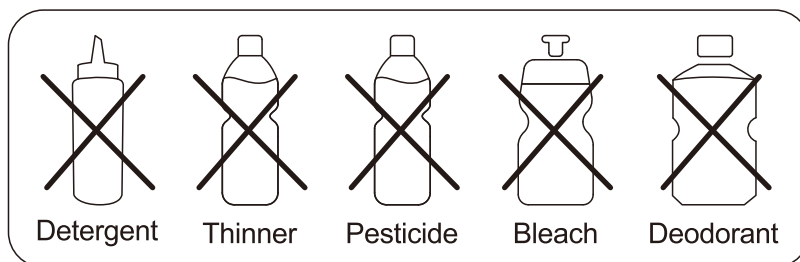

2. Please use a soft cloth to clean the nozzle cover and dry nozzle cover. Be careful not to damage the rubber seal.

3. Spray water on the toilet and clean it.

4. After cleaning, clean the whole cotton cloth.

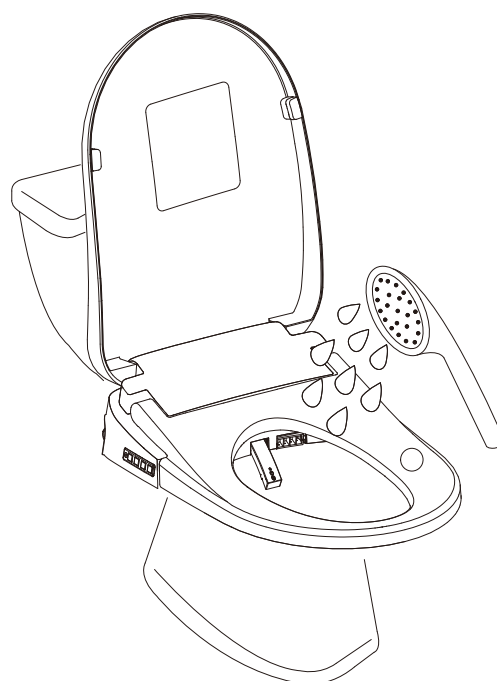
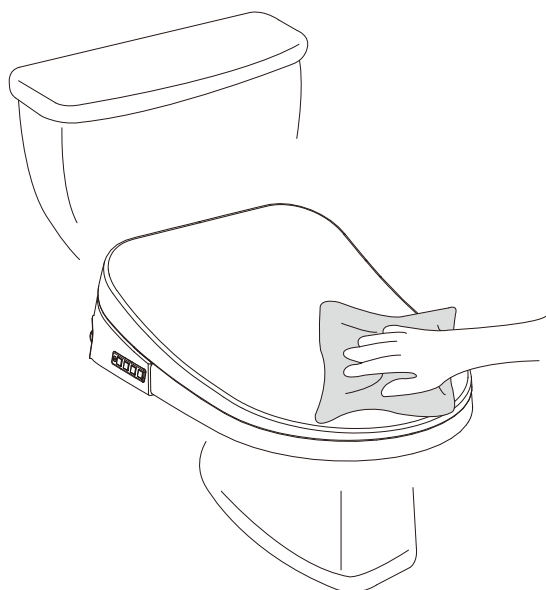

- Do not use strong detergent containing hydrochloric acid. Do not use deodorant. Refer to cleaning precautions.

### ③ How to clean the gap between smart cover and ceramic toilet.

1. Press the disassemble button below the right side of the toilet to detach it.
2. Clean the nozzle cover and the drying nozzle cover under the toilet bowl with a soft cloth or and clean the lower part of the toilet bowl and the ceramic seat toilet with a tool for cleaning.
3. After cleaning, clean the whole a cotton cloth and install the toilet.

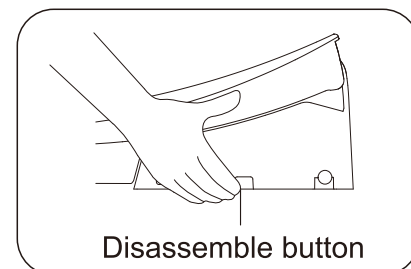

### ④ Seat toilet management methods in winter

In order to prevent freezing in winter, please follow the following methods to manage.

1. Check whether the power plug is properly inserted into the socket.
2. When the bathroom has no heating device, please use cloth to wrap connecting pipes or other insulating materials for insulation.

• **Note:**

**Please tighten the filter firmly, otherwise it may cause water leakage.**

**Do not grab the filter net too strongly as it may distort or rupture.**

**When blockage blocks the filter, the pressure of the flushing water may not be enough, so please change the filter regularly. The filter is usually replaced every six months. If you do not regularly change the filter, the buyer shall be responsible for the consequences of the malfunction. Please clean the toilet filter regularly once in three months.**

**We recommend that you do not use detergent when cleaning. Clean it directly with tap water.**

## 9、 Trouble shooting

Problems		Check	Handling
	Functions does not work at all.	The seat sensing area uses cloth cover, mat and other items.	Please remove the cloth cover, mat and other items.
		Power is cut.	Please wait for power recovery.
		Socket is loose or poor contact.	Plug in, ensure good power supply.
		Whether the power reset button is pressed.	Please press the power button on the toilet.
Flushing	Water doesn't come out.	No water.	Please wait for the water supply to resume.
		Water inlet valve is clogged with dirt.	Open the inlet valve.
		Filter is clogged with dirt.	Please change or clean the filter.
		Whether the water supply tube is bent and clogged.	Eliminate the water supply pipe bending.
	Flushing power is not strong enough.	Water pressure is set at low-grade.	Please adjust the water potential power by "button description" on the remote control.
		Filter is clogged with dirt.	Please change or clean the filter.
		Clean the nozzle to see if there is any blockage.	Please clean the nozzle.
	Water temperature is not high enough.	Whether the water temperature is set at low or normal temperature.	Please reset the water temperature by "button description" on the remote control.
	No water supply when flushing.	Press the "Rear Wash" or "Front Wash" key for about 60s, the machine will automatically stop.	Please click "Rear Wash" or "Front Wash" key again.
	Toilet Seat	The heated seat is not heating.	Thermal seat's heating strength is set in the low or off state.
The toilet is set in the energy-saving state.			Please exit energy-saving state.
Whether the power outage.			Please wait for power recovery.

## Thank you for choosing us

The company is committed to product development and improvement. If there is any difference between the original manual and the improved one, please read the corresponding version of the manual. We apologize for any inconvenience.