

Celia 2 In 1 Twin Shower

Nero

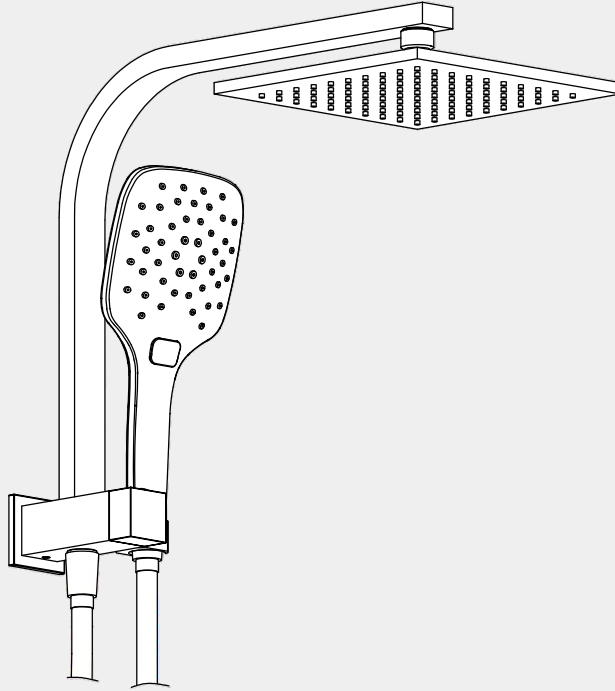

Versions:202401

Drawing

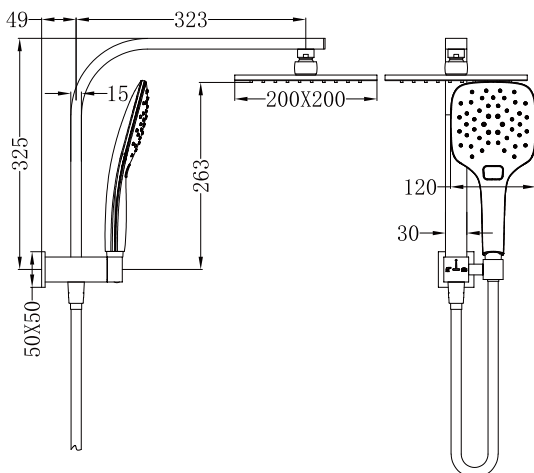

Specifications

Watermark License

WM-060093

Temperature Rating

Min 1°C-Max 75°C

Pressure Rating

Min 150kpa - Max 500kpa

Finish & SKU

Chrome
NR301505bCH

Packaging Includes

1x Shower Arm
1x Shower Head
1x Hand Shower (Built-In Check Valve)
1x 1.5m PVC Hose

*Dimensions are nominal measurements only.

Installation Instruction

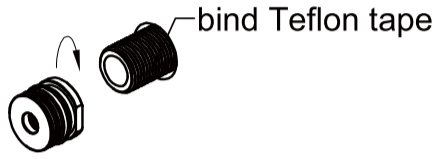
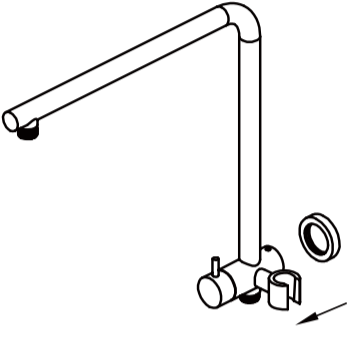
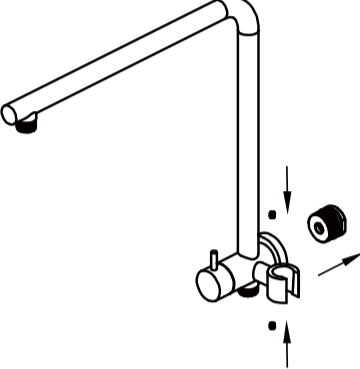
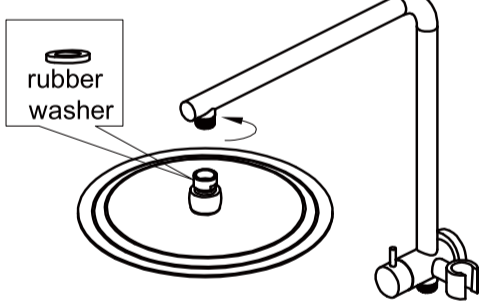
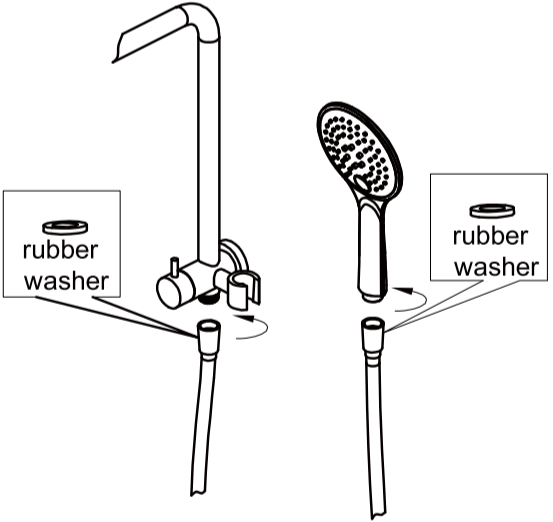
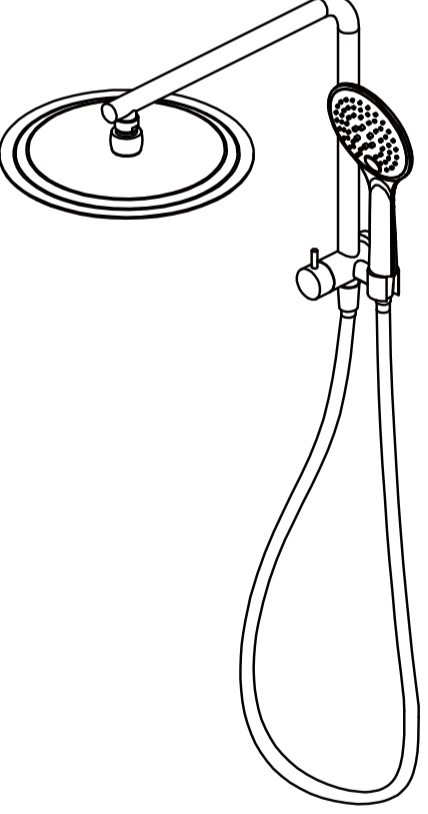
 <p>1. Screw threaded adaptor to the outlet tighten firmly with allen key.</p>	 <p>2. Push shower arm cover onto shower arm.</p>	 <p>3. Push shower arm cover on thread adaptor and tighten grub screws.</p>
 <p>4. Screw on shower head. (note the rubber washer in the shower head.)</p>	 <p>5. Screw shower hose to hand shower and shower rail.</p>	 <p>6. Finish.</p>

Nero

info@nerotapware.com.au
nerotapware.com.au

11-13 Buontempo Road
Carrum Downs Vic 3201

