

# Universal Pop Up Waste

# Nero

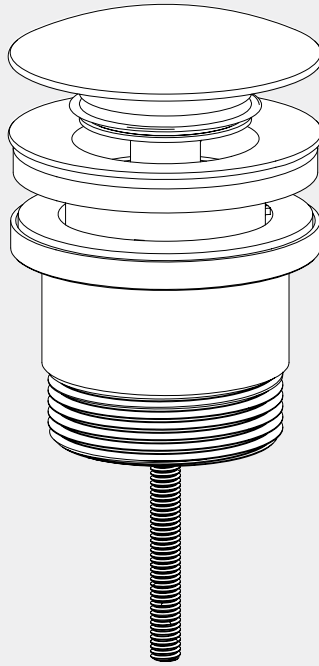

Versions:202311



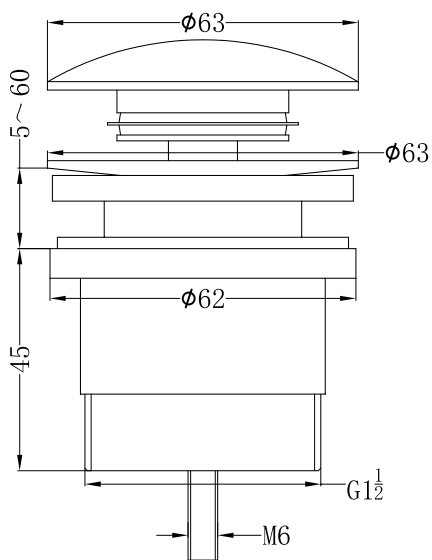





## Drawing



## Specifications

**SKU**  
NRA706  
**Watermark License**  
WMK26021

## Finish

 Chrome NRA706CH	 Gun Metal NRA706GM	 Brushed Bronze NRA706BZ	 Graphite NRA706GR
 Matte Black NRA706MB	 Brushed Gold NRA706BG	 Matte White NRA706MW	 Brushed Nickel NRA706BN
 Aged Brass NRA706AB			

\*Dimensions are nominal measurements only.

## Packaging Includes

1x pop up waste

# Installation Instruction

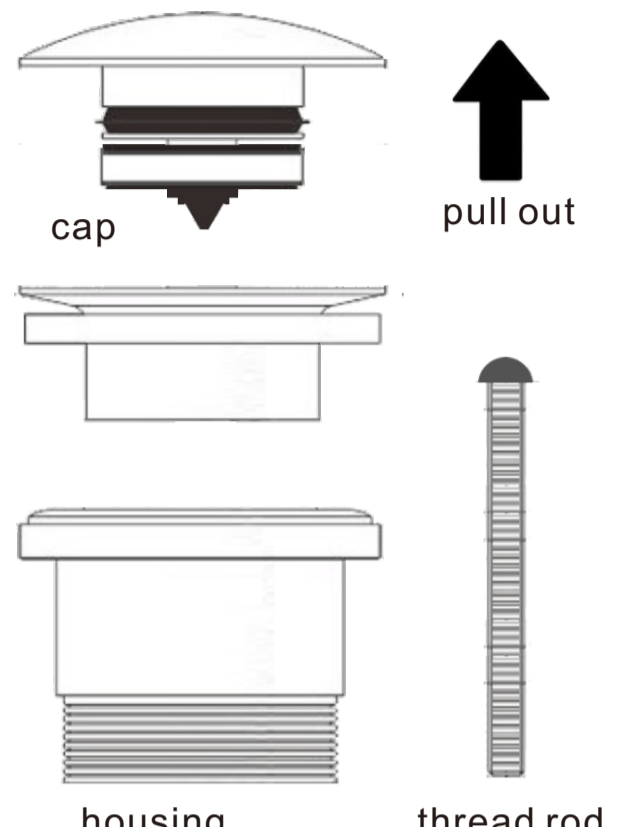
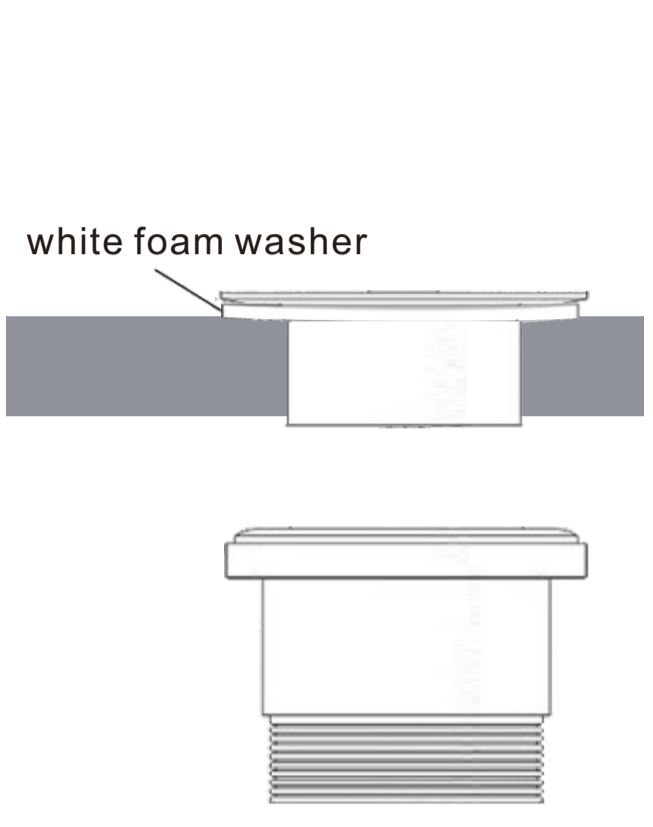
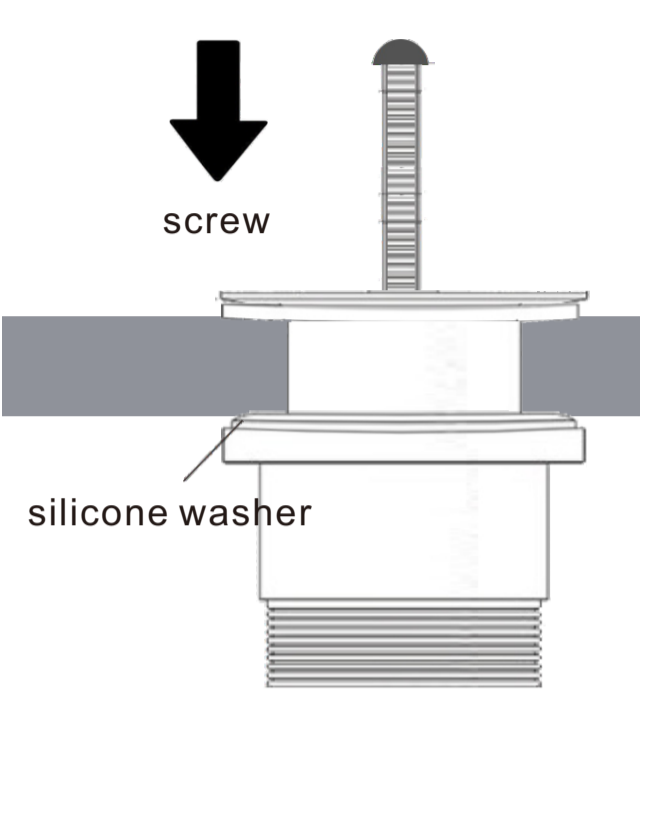
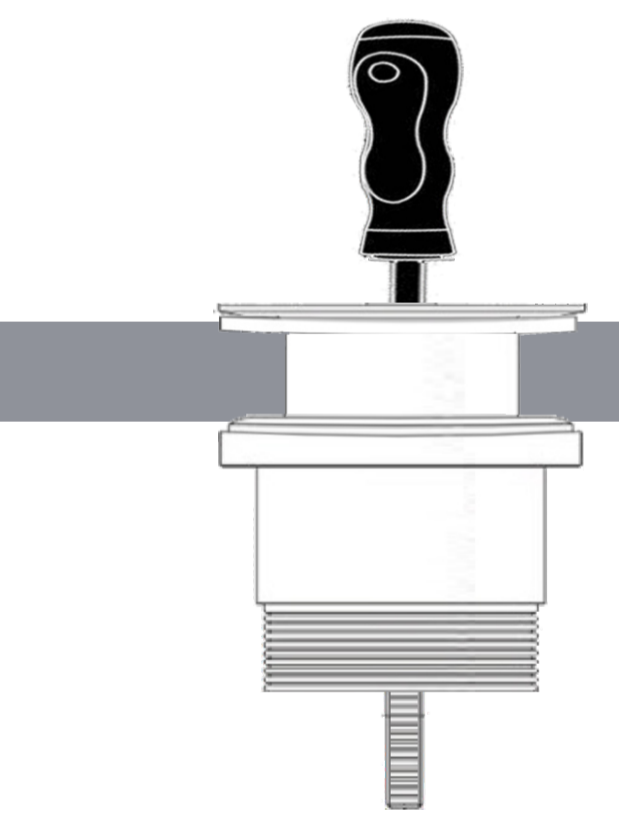
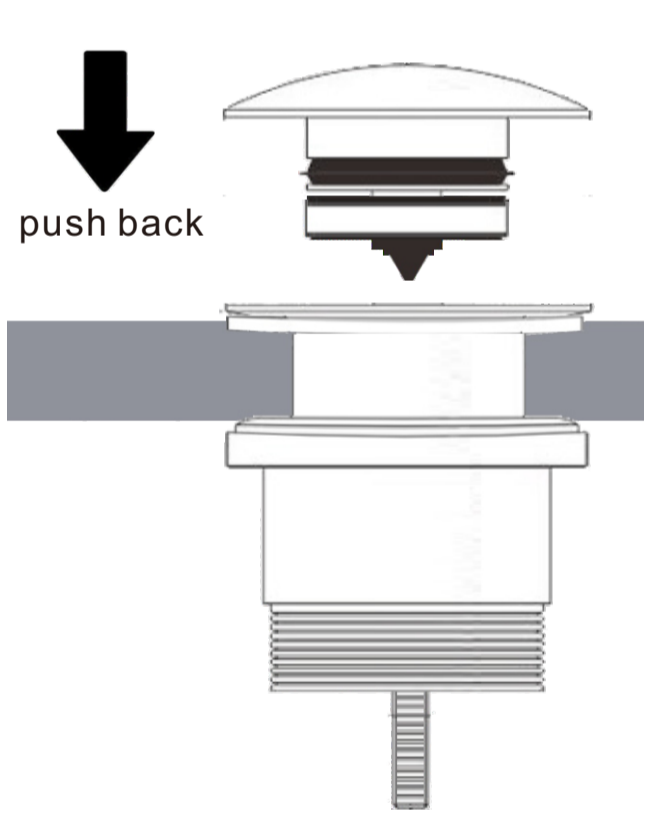
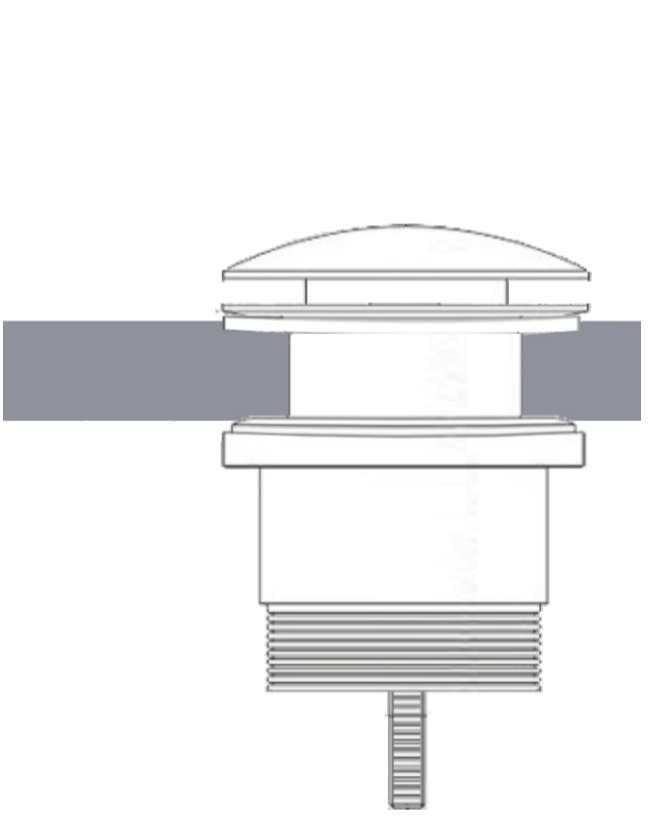
 <p>1. Disassemble pop-up waste by pulling out the cap and unscrewing the housing from the thread rod.</p>	 <p>2. Put waste through in basin hole and make white foam washer fitted to upper side of the basin.</p>	 <p>3. Put the housing covering on basin hole at bottom side. Screw thread rod through waste and housing in a row.</p>
 <p>4. Tighten up the thread rod by screw driver.</p>	 <p>5. Push back the cap.</p>	 <p>6. Finish, and check for leaks.</p>

# Nero

[info@nerotapware.com.au](mailto:info@nerotapware.com.au)  
[nerotapware.com.au](http://nerotapware.com.au)

11-13 Buontempo Road  
Carrum Downs Vic 3201

